



FOSHAN HK BUILDING MATERIAL COMPANY

Wedding stage and frame catalog

One-stop solution for your Self-built houses or construction projects

Save your time, Save your cost!

GL-Q22/GL-Q29/GL-Q30 / GL-Q30 Square/四方架

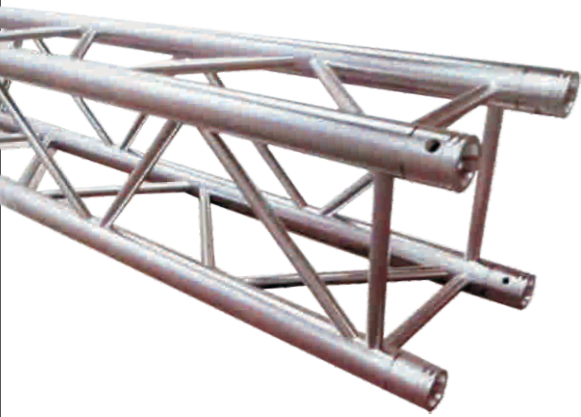

This truss is adapted for The Fair Constructron,Shop Fitting and Ad vertisement, Thjs fruss system GL29 offers an opifimum liftjng capa cjtand indicates a low transport volume with its lightweight ConStruction, it is possjbf to do a power Coating Or a high gloss/hand polished design Within the deliVery periode.

此系列展示架重量轻,体积小适用于展会酒店,商城广告场所,表面可以做烤漆,阳极处理。

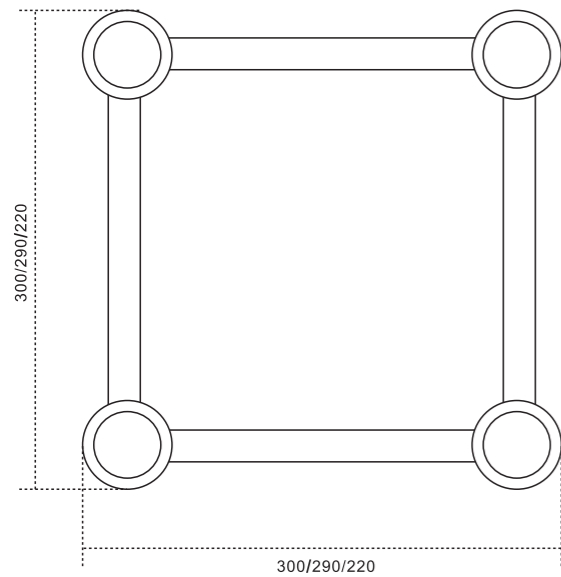

规格材质 / Technical Date	
主管管径/Main tube	30*3mm / 50*3mm
副管/Horizontal tube	20*2mm
斜管 /Snakebrace	20*2mm
材 质/Material	6082/6061-T6

产品规格/Product size	长度/LENGTH
220X220MM	500MM
	1000MM
	1500MM
	2000MM
290X290MM	2500MM
300X300MM'	3000MM
350X350MM	3500MM
	4000MM

GL-Q22 四方架 / Square												
Span(m)	1	2	3	4	5	6	7	8	9	10	11	12
Distribution load(kg/m)	381	190	124	94	75	52	41	30	24	18	15	12
Deflection(mm)	1	3	7	15	21	31	43	56	70	87	105	125
Center point load(kg)	381	372	343	256	204	169	141	121	107	93	84	74
Deflection(mm)	1	3	7	11	17	21	34	45	57	70	85	101

GL-Q29 / GL-Q30 / GL-Q35 四方架 / Square														
Span(m)	1	2	3	4	5	6	7	8	9	10	11	12	13	14
Distribution load(kg/m)	1952	986	668	498	402	327	241	188	152	130	100	83	71	62
Deflection(mm)	2	4	9	18	27	36	51	67	74	86	105	125	151	175
Center point load(kg)	1952	1905	1776	1476	1160	958	831	717	623	566	501	460	410	360
Deflection(mm)	2	3	7	12	21	31	41	54	68	84	105	120	143	165

GL-Q40/GL-Q45/GL-Q52 Square/四方架



规格材质 Technical Date	
主管管径/Main tube	50*3mm
副管/Horizontal tube	50*2mm / 25*2mm
斜管 /Snakebrace	25*2mm
材 质/Material	6082/6061-T6

产品规格/Product size	长度/LENGTH
400X400MM	500MM
	1000MM
	1500MM
	2000MM
450X450MM	2500MM
520X520MM	3000MM
	3500MM
	4000MM

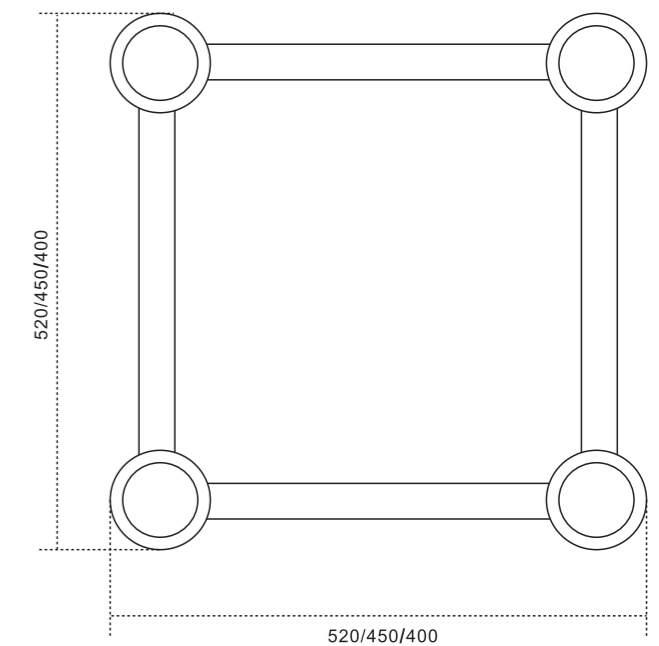

GL-Q40 四方架 / Square														
Span(m)	3	4	5	6	7	8	9	10	11	12	13	14	15	16
Distribution load(kg/m)	936	732	465	320	232	176	136	110	90	72	61	52	44	38
Deflection(mm)	5	7	10	15	21	30	35	37	45	56	68	80	85	90
Center point load(kg)	718	680	644	612	585	560	535	514	492	444	400	363	335	303
Deflection(mm)	3	5	7	8	11	17	21	28	35	42	50	55	63	70

GL-Q45 四方架 / Square															
Span(m)	5	6	7	8	9	10	11	12	13	14	15	16	17	18	
Distribution load(kg/m)	680	566	421	308	288	199	166	111	100	92	80	71	65	52	
Deflection(mm)	15	21	31	34	38	46	57	67	81	88	92	98	103	118	
Center point load(kg)	1200	1122	944	890	799	733	702	673	620	588	543	492	458	420	
Deflection(mm)	11	15	20	23	27	32	44	52	63	72	81	88	92	100	

GL-Q52 四方架 / Square															
Span(m)	7	8	9	10	11	12	13	14	15	16	17	18	19	20	
Distribution load(kg/m)	460	346	303	241	182	164	135	118	99	84	75	68	60	54	
Deflection(mm)	20	30	42	53	62	76	90	104	121	135	155	170	195	209	
Center point load(kg)	1255	1130	1008	923	885	182	706	661	622	599	565	547	527	503	
Deflection(mm)	10	16	21	28	37	45	55	67	80	94	107	125	143	163	

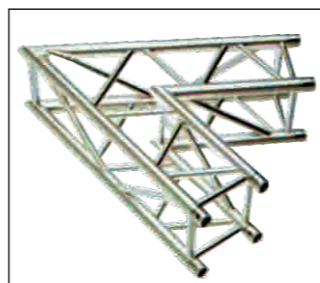

两面60° 接头
2-way 60° corner



两面90° 接头
2-way 90° corner

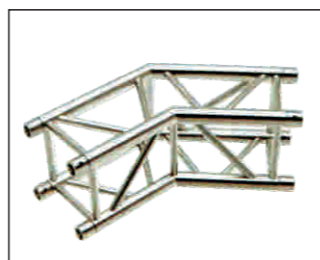

两面120° 接头
2-way 120° corner

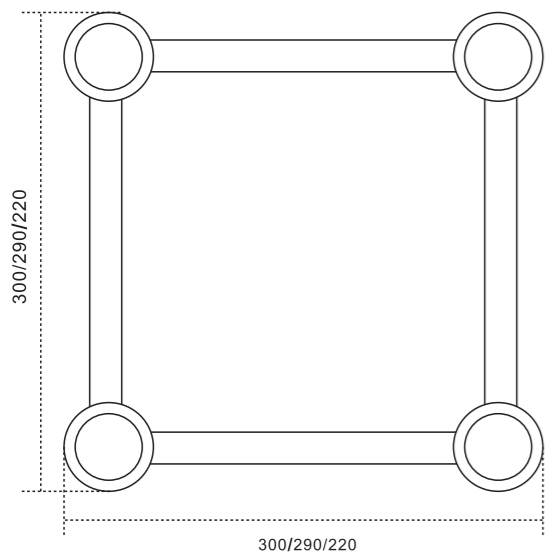

300/290/220



三面T字接头
3-way 90° corner T



三面90° 接头
3-way 90° corner



四面90° 接头
4-way 90° corner



四两面90° 接头
4-way 90° corner cross



五面90° 接头
5-way 90° corner

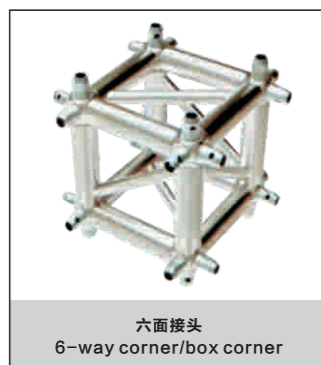

六面接头
6-way corner/box corner



底板A
PLATE-A



底板B
PLATE-B

300/290/220

GL-Q4060/GL-Q5060 Square/四方架

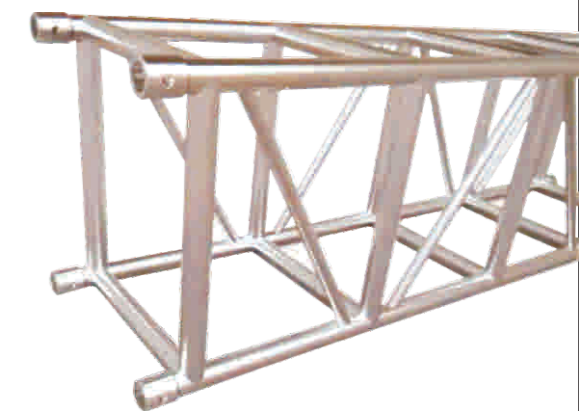

规格材质/Technical Date	
主管管径/Main tube	50*3mm
副管/Horizontal tube	50*2mm
斜管 /Snakebrace	25*2mm
材质/Material	6082/6061-T6

产品规格/Product size	长度 / LENGTH
400X600MM	500MM
	1000MM
	1500MM
	2000MM
	2500MM
	3000MM
500X600MM	3500MM
	4000MM

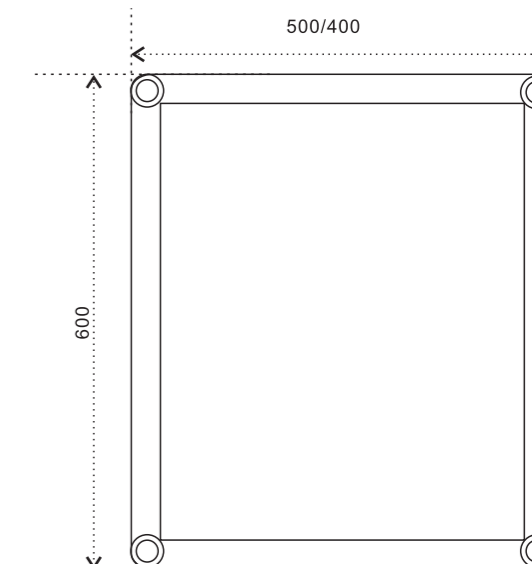

GL-Q4060 四方架/Square														
Span(m)	7	8	9	10	11	12	13	14	15	16	17	18	19	20
Distribution load(kg/m)	450	336	299	236	178	158	130	111	92	79	73	62	57	50
Deflection(mm)	20	30	42	53	62	76	90	104	121	135	155	170	195	209
Center point load(kg)	1205	1100	998	903	824	733	695	628	599	548	502	488	459	440
Deflection(mm)	10	16	21	28	37	45	55	67	80	94	107	125	143	163
GL-Q5060 四方架/Square														
Span(m)	6	8	10	12	13	14	15	16	17	18	19	20	21	22
Distribution load(kg/m)	2088	1910	1750	1530	1490	1450	1200	1088	998	902	851	800	750	700
Deflection(mm)	18	25	39	53	59	65	73	87	93	100	113	125	132	138
Center point load(kg)	960	861	758	660	595	548	501	460	428	405	382	360	335	300
Deflection(mm)	5	6	11	18	20	22	29	35	41	48	54	60	68	74

GL-Q5276/GL-Q6076 Square/四方架

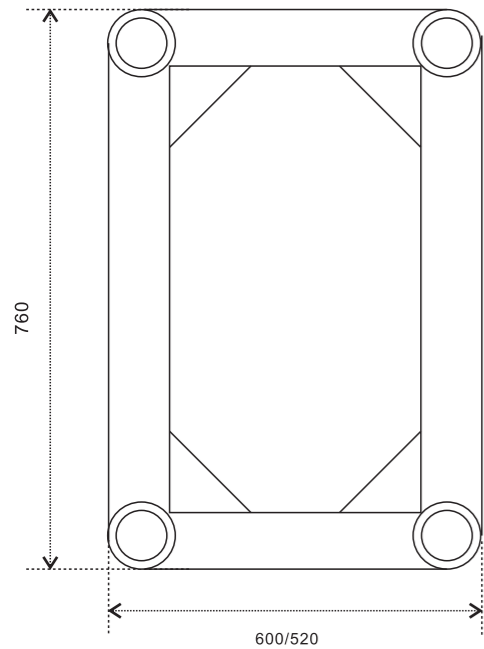
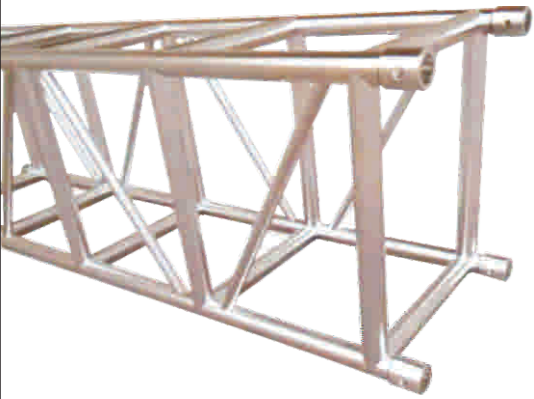

规格材质/Technical Date	
主管管径/Main tube	50*3mm/50*4mm
副管/Horizontal tube	50*2mm
斜管 /Snkebrace	30*2mm
材质/Material	6082/6061-T6

产品规格/Product size	长度 / LENGTH
520X760MM	500MM
	1000MM
	1500MM
	2000MM
	3000MM
	4000MM
600X760MM	2500MM
	3000MM
	3500MM
	4000MM

GL-Q5276														
Span(m)	8	10	12	14	15	16	17	18	19	20	21	22	23	24
Distribution load(kg/m)	2100	1898	1698	1600	1488	1398	1298	1200	1095	1005	902	792	720	675
Deflection(mm)	24	40	52	66	73	86	92	101	112	124	132	138	141	145
Center point load(kg)	1198	1100	998	930	885	840	798	750	700	645	565	475	405	368
Deflection(mm)	20	26	34	39	42	51	56	61	67	71	77	83	90	96
GL-Q6076														
Span(m)	8	10	12	14	16	18	19	20	21	22	23	24	25	26
Distribution load(kg/m)	2200	2045	1850	1700	1520	1332	1192	1098	988	898	793	688	584	482
Deflection(mm)	24	40	52	66	73	86	92	101	112	124	132	138	141	145
Center point load(kg)	1266	1163	1058	952	850	748	698	647	594	546	498	450	402	350
Deflection(mm)	20	26	34	39	42	51	56	61	67	71	77	83	90	96

GL-Q58101 Square/四方架

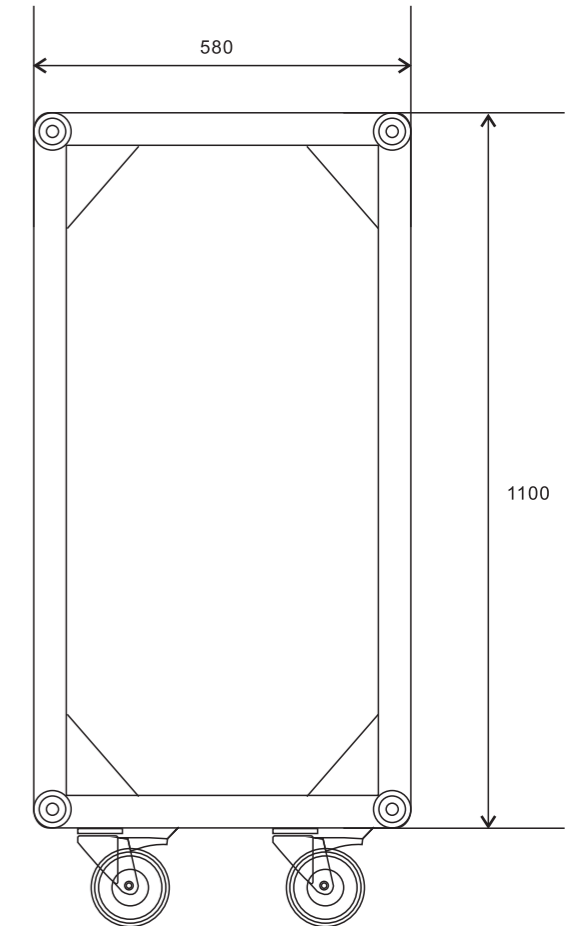

规格材质/Technical Date	
主管管径/Main tube	60*5mm
副管/Horizontal tube	50*3mm
斜管 /Snkebrace	30*3mm
材质/Material	6082/6061-T6

产品规格/Product sizeL	长度 / LENGTH
580x1100MM	500MM
	1000MM
	2000MM
	3000MM
	4000MM

GL-Q58101														
Span(m)	5	6	7	8	9	10	11	12	13	14	15	16	17	18
Distribution load(kg/m)	12213.5	12193.5	11401	9945.6	8808	7895.8	7145.2	6919.5	5957.5	5525.8	5126	4775.3	4461	4182.6
Deflection(mm)	5	7	8	13	16	17	23	26	30	35	45	49	55	61
Center point load(kg)	9662.5	8033	8033	5991.5	5306.5	4757.2	4306.8	3926.5	3606.2	3328.2	3087.5	2874.9	2869.2	2517.5
Deflection(mm)	5	7	12	14	20	22	26	35	40	47	50	60	68	76

GL-Q58101														
Span(m)	19	20	21	22	23	24	25	26	27	28	29	30	31	32
Distribution load(kg/m)	3928.2	3699.5	3490	3299	3124	2961	2810	2670	2538	2415	2299.3	2190.5	2085.5	1989
Deflection(mm)	68	75	80	90	100	107	115	128	138	147	156	168	177	190
Center point load(kg)	2365.8	2228.5	2102.5	1986.5	1882.5	1782.8	1693.3	1608.2	1529.4	1454.9	1385.2	1317.5	1256	1197.5
Deflection(mm)	82	95	101	115	125	135	145	156	169	180	195	209	221	236

GL-Q58101														
Span(m)	33	34	35	36	37	38	39	40						
Distribution load(kg/m)	1895	1806	1722.5	1643	1565	1490	1418.5	1350						
Deflection(mm)	200	215	226	241	254	267	280	295						
Center point load(kg)	1141.5	1088	1038	989.5	942.5	899	854.5	812						
Deflection(mm)	253	266	284	300	315	335	350	368						

GL-T29 Triangle/三角架

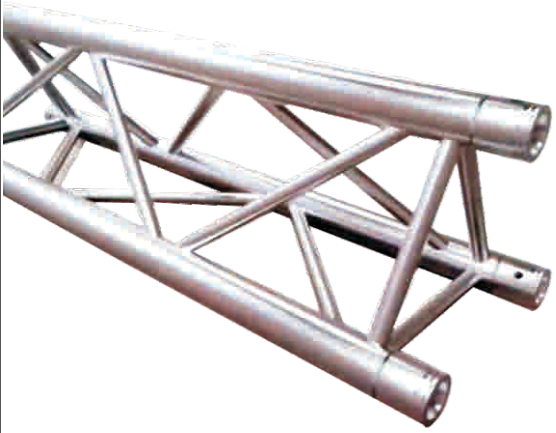

规格材质/Technical Date	
主管管径/Main tube	50*3mm
副管/Horizontal tube	20*2mm
斜管/Snkebrace	20*2mm
材质/Material	6082/6061-T6

产品规格/Product size	长度 / LENGTH
290MM三角架	500MM
	1000MM
	1500MM
	2000MM
	2500MM
	3000MM
	3500MM
4000MM	

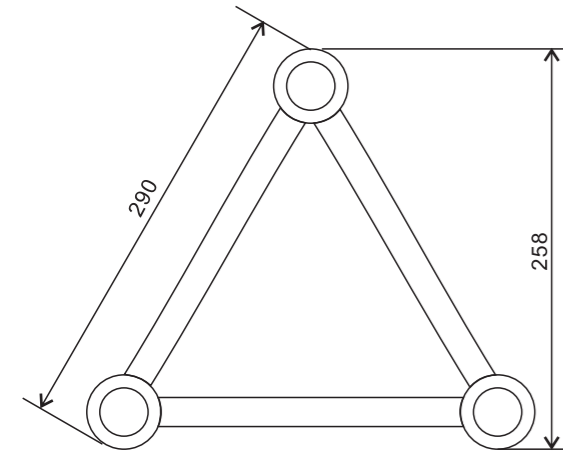

GL-T29 三角架 / Triangle														
Span(m)	1	2	3	4	5	6	7	8	9	10	11	12		
Distribution load(kg/m)	1715	862	402	226	142	98	72	54	42	33	26	22		
Deflection(mm)	1	4	9	14	22	33	43	58	74	88	105	125		
Center point load(kg)	1715	909	608	445	353	296	247	215	185	162	145	129		
Deflection(mm)	1	3	6	12	19	25	36	45	58	71	86	104		

GL-T29弯头 / Corner

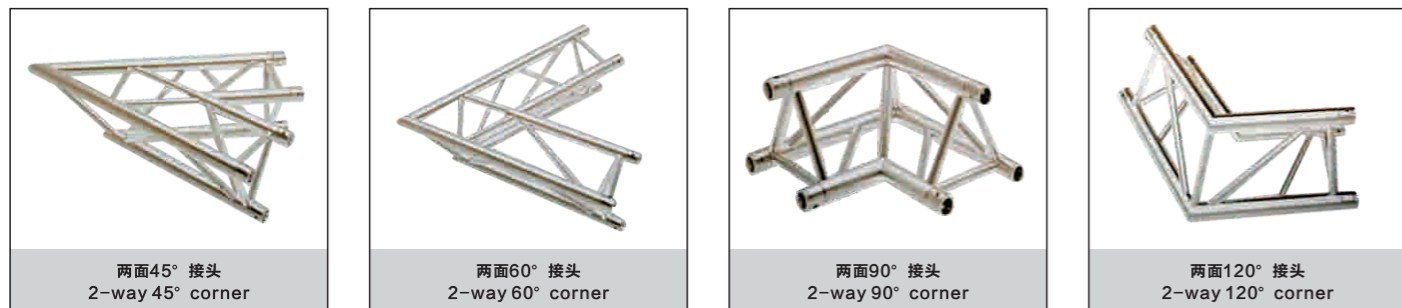

GL-T29弯头 / Corner

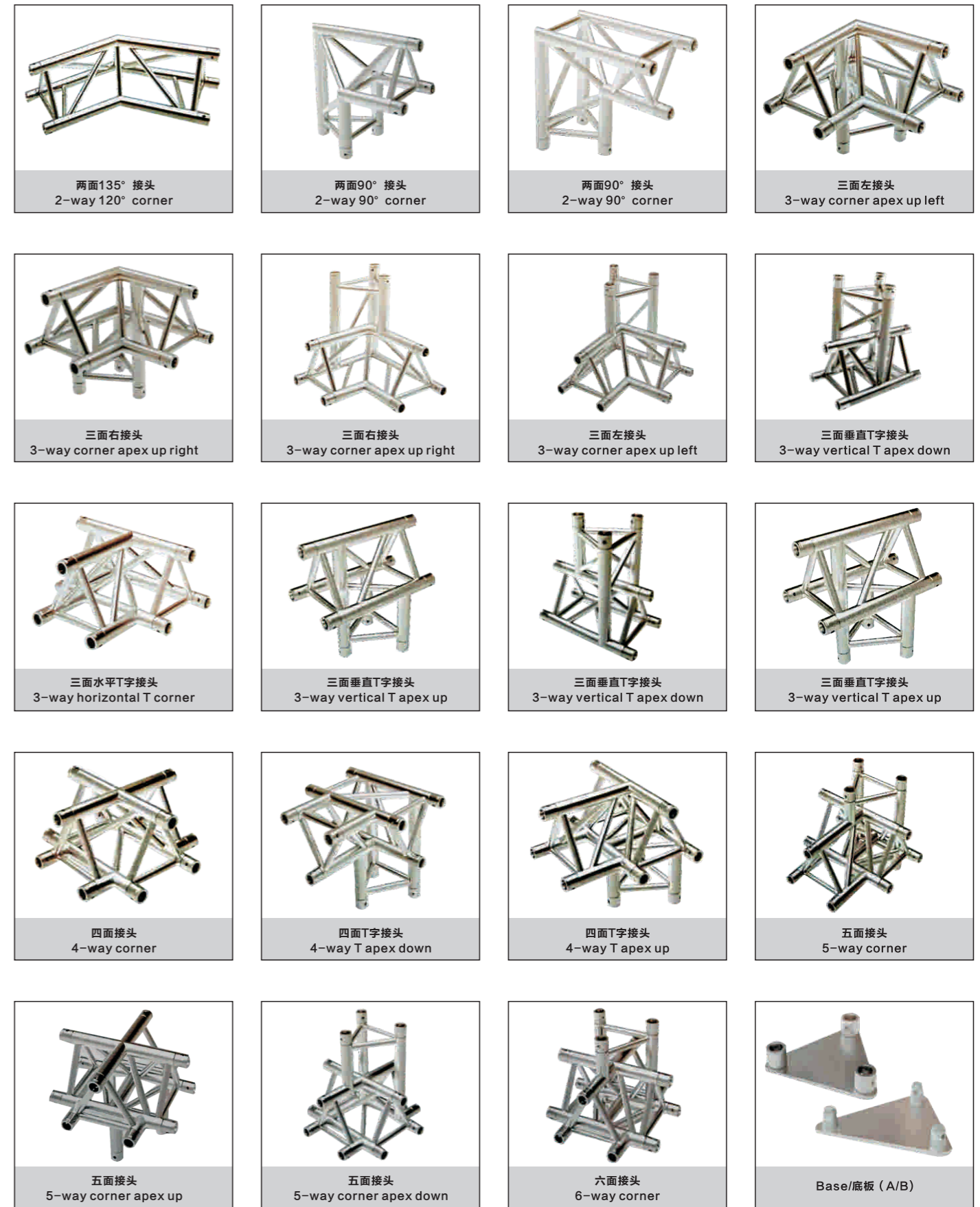

GL-S29 Step/单排架

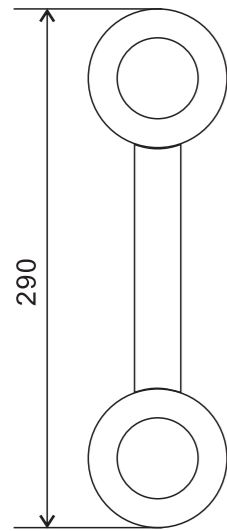
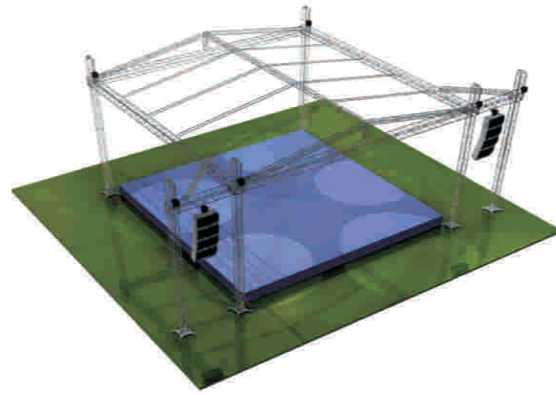

规格材质/Technical Date	
主管管径/Main tube	50*3mm
副管/Horizontal tube	20*2mm
斜管/Snkebrace	20*2mm
材质/Material	6082/6061-T6

产品规格/Product size	长度 / LENGTH
290MM单排架	500MM
	1000MM
	1500MM
	2000MM
	2500MM
	3000MM
	3500MM
4000MM	

GL-S29 单排架 / Step										
Span(m)	1	2	3	4	5	6				
Distribution load(kg/m)	990	340	115	43	20	10				
Deflection(mm)	1	1	2	3	3	3				
Center point load(kg)	990	340	168	87	51	26				
Deflection(mm)	1	1	2	2	2	2				

GL-S29接头 / Corne



GL-S29接头 / Corne



GL-M30 / GL-M35 / GL-M40 目字管架

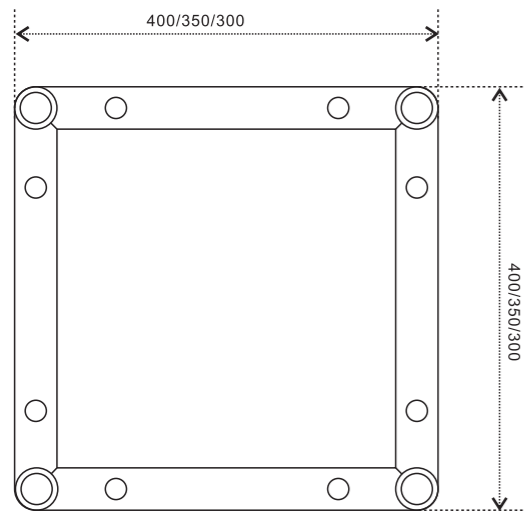
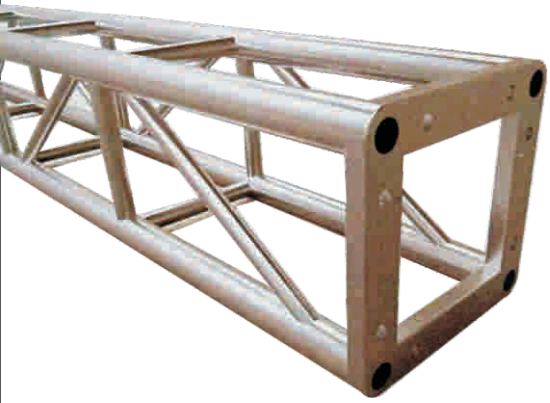

规格材质/Technical Date	
主管管径/Main tube	50*3mm
副管/Horizontal tube	30*2mm
斜管 /Snkebrace	25*2mm
材 质/Material	6082/6061-T6

产品规格/Product size	长度 / LENGTH
300X300MM	500MM
	1000MM
	1500MM
350X350MM	2000MM
	2500MM
400X400MM	3000MM
	3500MM
	4000MM

GL-M20 / GL-M30 目字管架												
跨度 (M)	1	2	3	4	5	6	7	8	9	10	11	12
总载荷载 (KG)	1548	1382	1098	840	658	550	462	402	352	311	281	261
弯度(MM)	1	3	7	12	21	31	41	54	68	84	105	120
中心荷载 (KG)	1548	772	502	377	365	272	195	136	118	103	92	88
弯度(MM)	2	4	9	12	26	39	53	72	89	105	120	135

GL-M40 目字管架														
跨度 (M)	2	3	4	5	6	7	8	9	10	11	12	13	14	15
总载荷载 (KG)	1788	1632	1498	1306	1158	998	858	746	641	551	498	448	401	348
弯度(MM)	1	3	7	12	21	31	41	54	68	84	105	120	105	120
中心荷载 (KG)	1098	733	555	437	358	281	229	178	148	129	103	82	71	64
弯度(MM)	2	4	9	12	26	39	53	72	89	105	120	135	120	135

GL-M3040 目字管架



规格材质/Technical Date	
主管管径/Main tube	50*3mm
副管/Horizontal tube	30*2mm
斜管 /Snkebrace	25*2mm
材 质/Material	6082/6061-T6

产品规格/Product size	长度 / LENGTH
300X400MM	500MM
	1000MM
	1500MM
	2000MM
	2500MM
	3000MM
	3500MM
	4000MM

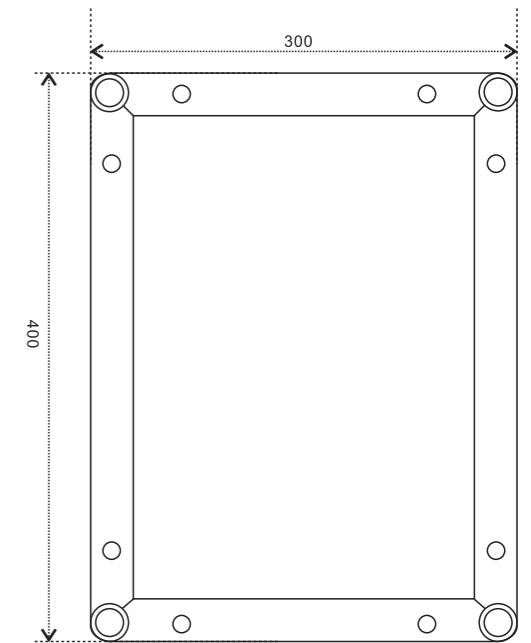

GL-M3040 目字管架																
Span(m)	1	2	3	4	5	6	7	8	9	10	11	12	13	14		
Distribution load(kg/m)	1688	1522	1298	980	778	669	588	521	485	422	381	308	281	251		
Deflection(mm)	1	3	7	12	21	31	41	54	68	84	105	120	105	120		
Center point load(kg)	1688	903	795	699	521	406	322	266	188	158	133	112	96	82		
Deflection(mm)	2	4	9	12	26	39	53	72	89	105	120	135	120	135		

GL-B30/GL-B35 / GL-B40 铝板架

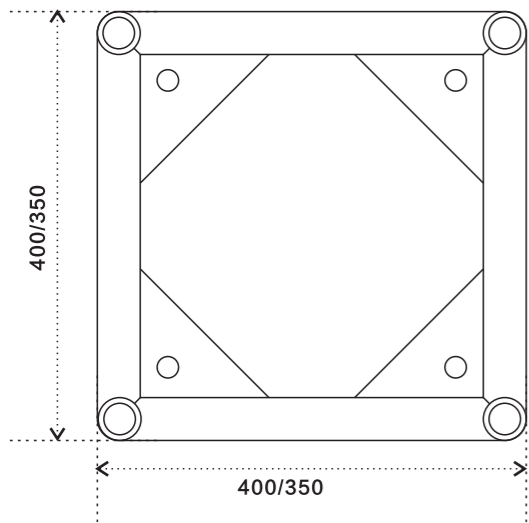
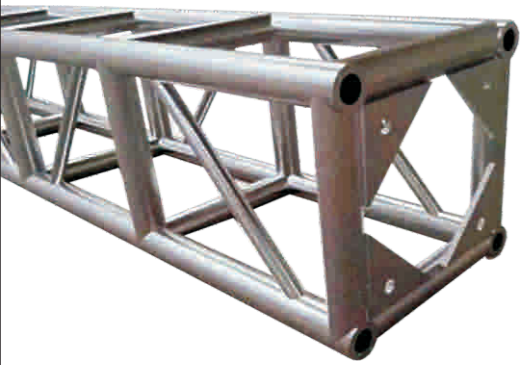

规格材质 / Technical Date	
主管管径/Main tube	50*3mm
副管/Horizontal tube	50*2mm
斜管 /Snakebrace	25*2mm
材质/Material	6082/6061-T6

产品规格/Product size	长度 / LENGTH
300X300MM	500MM
	1000MM
	1500MM
	2000MM
350X350MM	2500MM
	3000MM
400X400MM	3500MM
	4000MM

GL-B40 铝板架														
跨度 (M)	3	4	5	6	7	8	9	10	11	12	13	14	15	16
总载荷载 (KG)	936	732	465	320	232	176	136	110	90	72	61	52	44	38
弯度(MM)	5	7	10	15	21	30	35	37	45	56	68	80	85	90
中心荷载 (KG)	718	680	644	612	585	560	535	514	432	444	400	363	335	303
弯度(MM)	3	5	7	8	11	17	21	28	35	42	50	55	63	70
GL-B30/GL-B35铝板架														
跨度 (M)	3	4	5	6	7	8	9	10	11	12	13	14	15	16
总载荷载 (KG)	936	732	465	320	232	176	136	110	90	72	61	52	44	38
弯度(MM)	5	7	10	15	21	35	30	37	45	56	68	80	85	90
中心荷载 (KG)	718	680	644	612	585	560	535	514	492	444	400	363	335	303
弯度(MM)	3	5	7	8	11	17	21	28	35	42	50	55	63	70

GL-B45 / GL-B50 铝板架

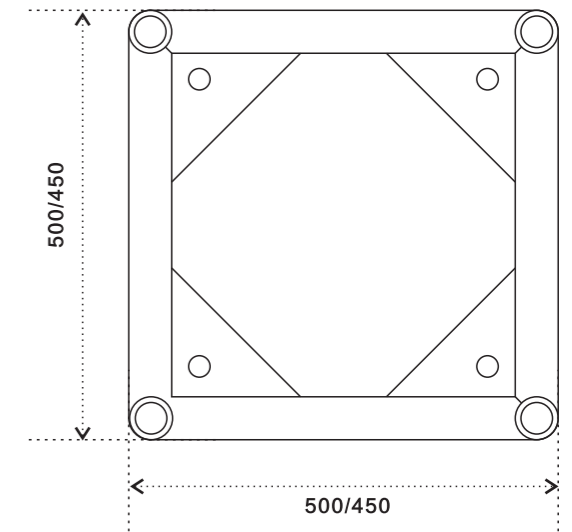
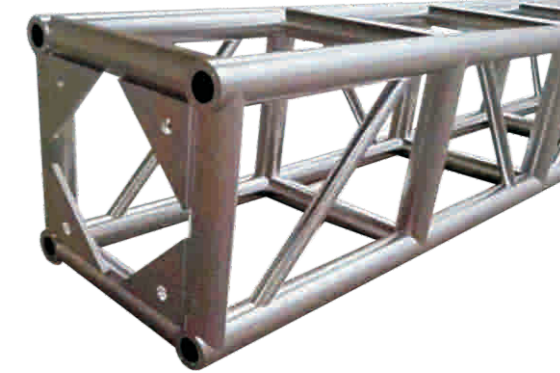

规格材质 / Technical Date	
主管管径/Main tube	50*3mm
副管/Horizontal tube	50*2mm
斜管 /Snakebrace	25*2mm
材质/Material	6082/6061-T6

产品规格/Product size	长度 / LENGTH
450X450MM	500MM
	1000MM
	1500MM
	2000MM
500X500MM	2500MM
	3000MM
	3500MM
	4000MM

GL-B50 铝板架														
跨度 (M)	7	8	9	10	11	12	13	14	15	16	17	18	19	20
总载荷载 (KG)	450	336	299	236	178	158	130	111	92	79	73	62	57	50
弯度(MM)	20	30	42	53	62	76	90	104	121	135	155	170	195	209
中心荷载 (KG)	1205	1100	998	903	824	733	695	628	599	548	502	488	459	440
弯度(MM)	10	16	21	28	37	45	55	67	80	94	107	125	143	163
GL-B45 铝板架														
跨度 (M)	5	6	7	8	9	10	11	12	13	14	15	16	17	18
总载荷载 (KG)	680	566	421	308	288	199	166	111	100	92	80	71	65	52
弯度(MM)	15	21	31	34	38	46	57	67	81	88	92	98	103	118
中心荷载 (KG)	1200	1122	944	890	799	733	702	673	620	588	543	492	458	420
弯度(MM)	11	15	20	23	27	32	44	52	63	72	81	88	92	100

GL-B4060 / GL-B5060 铝板架

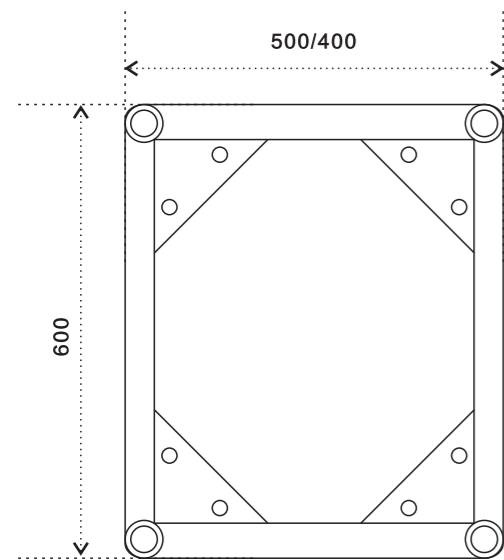

规格材质 / Technical Date	
主管管径/Main tube	50*3mm
副管/Horizontal tube	50*2mm
斜管/Snkebrace	25*2mm
材质/Material	6082/6061-T6

产品规格/Product size	长度 / LENGTH
500X600MM	500MM
	1000MM
	1500MM
	2000MM
	2500MM
	3000MM
	3500MM
	4000MM
400X600MM	500MM
	4000MM

GL-B4060 铝板架														
跨度 (M)	3	4	5	6	7	8	9	10	11	12	13	14	15	16
总载荷载 (KG)	936	732	465	320	232	176	136	110	90	72	61	52	44	38
弯度(MM)	5	7	10	15	21	35	30	37	45	56	68	80	85	90
中心荷载 (KG)	718	680	644	612	585	560	535	514	492	444	400	363	335	303
弯度(MM)	3	5	7	8	11	17	21	28	35	42	50	55	63	70
GL-B5060 铝板架														
跨度 (M)	3	4	5	6	7	8	9	10	11	12	13	14	15	16
总载荷载 (KG)	936	732	465	320	232	176	136	110	90	72	61	52	44	38
弯度(MM)	5	7	10	15	21	30	35	37	45	56	68	80	85	90
中心荷载 (KG)	718	680	644	612	585	560	535	514	432	444	400	363	335	303
弯度(MM)	3	5	7	8	11	17	21	28	35	42	50	55	63	70

GL-B5276 / GL-B6076 铝板架

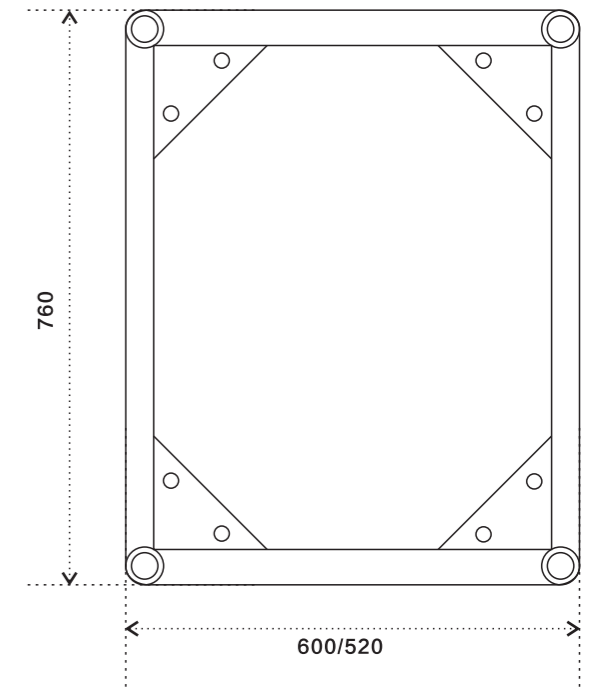

规格材质 / Technical Date	
主管管径/Main tube	50*3mm / 50*4mm / 十字管
副管/Horizontal tube	50*2mm
斜管/Snkebrace	30*2mm
材质/Material	6082/6061-T6

产品规格/Product size	长度 / LENGTH
520X760MM	500MM
	1000MM
	1500MM
	2000MM
	2500MM
	3000MM
	3500MM
	4000MM
600X760MM	500MM
	4000MM

GL-B5276 铝板架														
跨度 (M)	5	6	7	8	9	10	11	12	13	14	15	16	17	18
总载荷载 (KG)	680	566	421	308	288	199	166	111	100	92	80	71	65	52
弯度(MM)	15	21	31	34	38	46	57	67	81	88	92	98	103	118
中心荷载 (KG)	1200	1122	944	890	799	733	702	673	620	588	543	492	458	420
弯度(MM)	11	15	20	23	27	32	44	52	63	72	81	88	92	100
GL-B6076 铝板架														
跨度 (M)	7	8	9	10	11	12	13	14	15	16	17	18	19	20
总载荷载 (KG)	450	336	299	236	178	158	130	111	92	79	73	62	57	50
弯度(MM)	20	30	42	53	62	76	90	104	121	135	155	170	195	209
中心荷载 (KG)	1205	1100	998	903	824	733	695	628	599	548	502	488	459	440
弯度(MM)	10	16	21	28	37	45	55	67	80	94	107	125	143	163

GL-FT52 Folding truss/折叠桁架

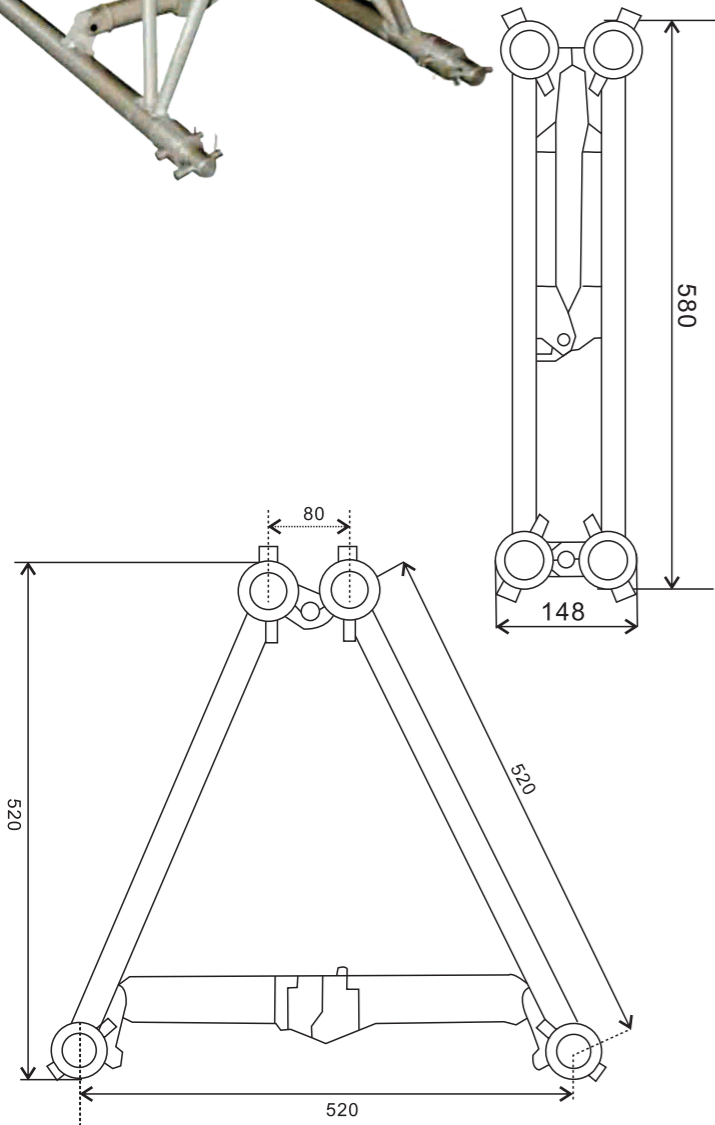
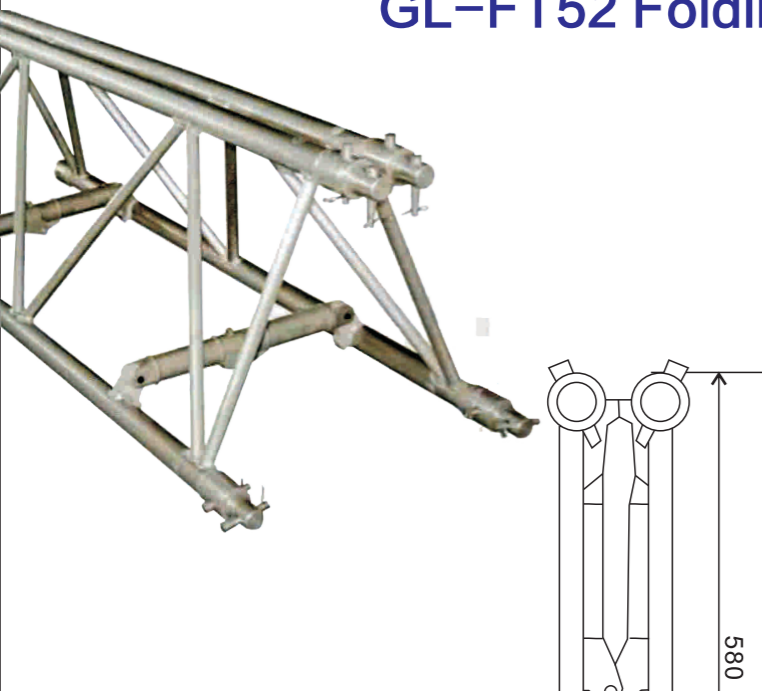

规格材质/Technical Date	GL-FT52
主管管径/Main tube	50*4mm
副管/Horizontal tube	30*2mm
斜管 /Snkebrace	30*2mm
材质/Material	6082/6061-T6

产品规格/Product size	长度 / LENGTH
520x520mm	500MM
	1000MM
	1500MM
	2000MM
	2500MM
	3000MM
	3500MM
	4000MM

GL-FT52 折叠桁架 / Folding truss														
Span(m)	8	10	12	14	15	16	17	18	19	20	21	22	23	24
Distribution load(kg/m)	2100	1898	1698	1600	1488	1398	1298	1200	1095	1005	902	792	720	675
Deflection(mm)	24	40	60	81	92	103	114	122	135	147	160	172	190	202
Center point load(kg)	1198	1100	998	930	885	840	798	750	700	645	565	475	405	368
Deflection(mm)	20	35	50	68	75	86	98	107	119	131	144	152	166	175

有时为了让桁架看起来更时尚美观，我们会对桁架表面做后期的工艺处理如：颜色多样化的阳极或烤漆。
Sometimes, to make the truss look more beautiful and fashionable, we Will do some finishing process onto the surface, such as anodization orPainting treatment of different colors.

阳极/Anodization

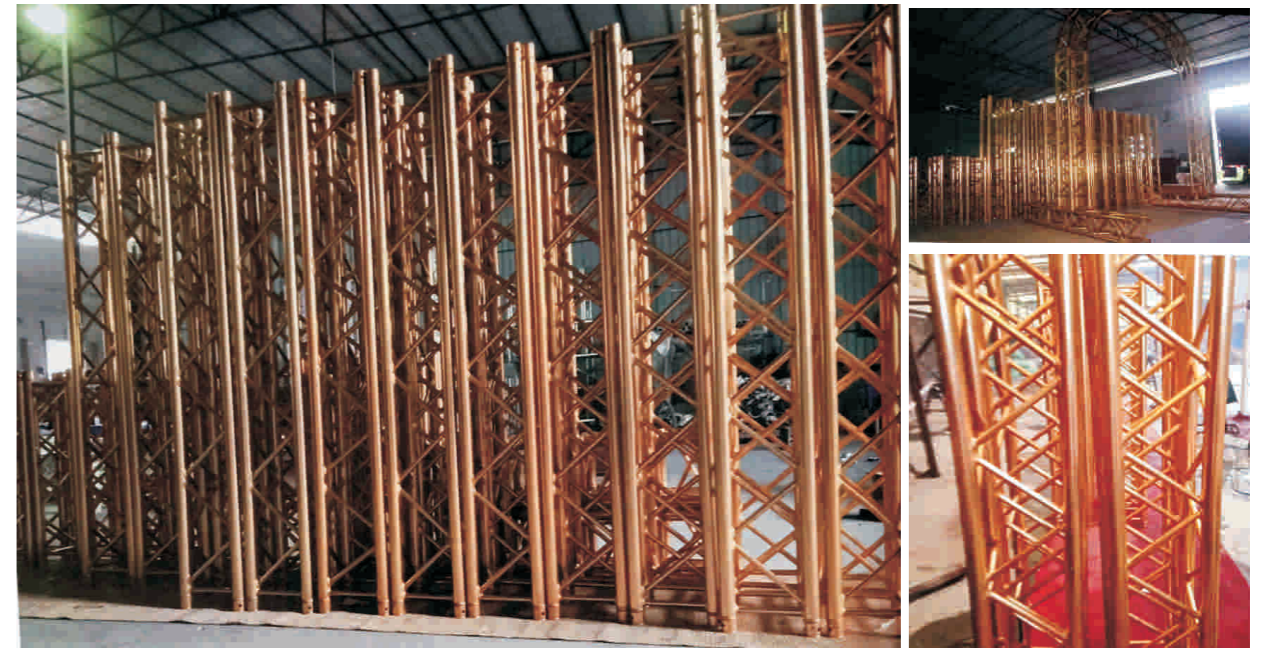

烤漆/Painting

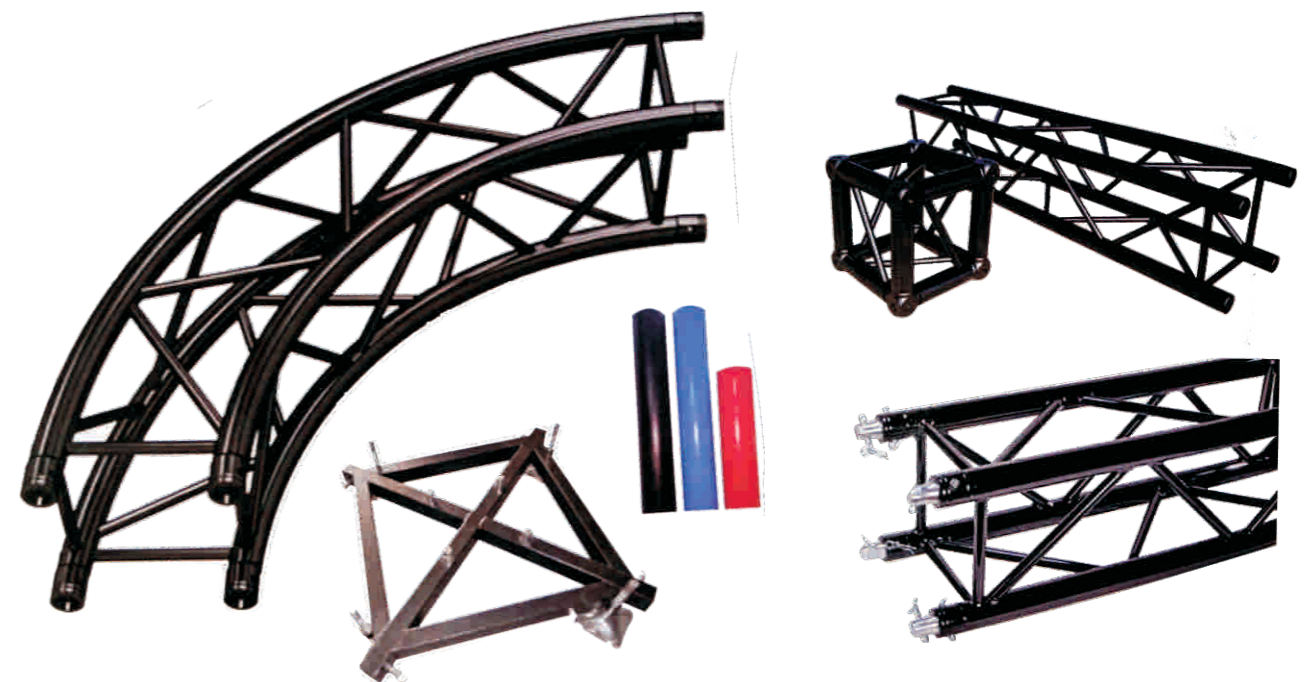

插销架配件 / Spigot Truss Accessories

插销架配件
Spigot Truss Accessories

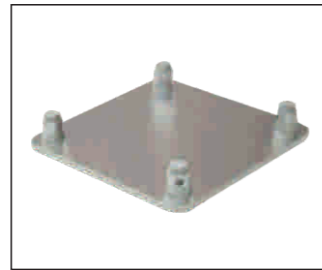

底座/Floor



底座/Base



底座/Base

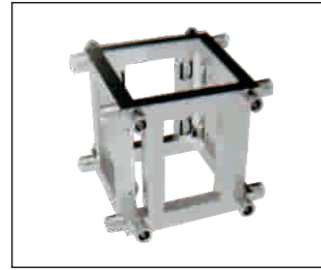

方套/Sleeve Block

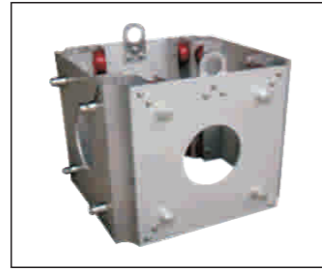

方套/Sleeve Block

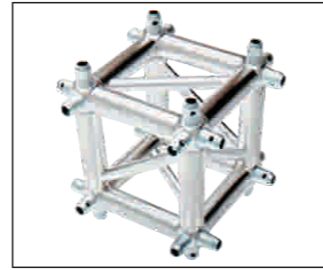

六面接头/Box Corner



插销架活结/Slipknot



单环扣/Half Coupler

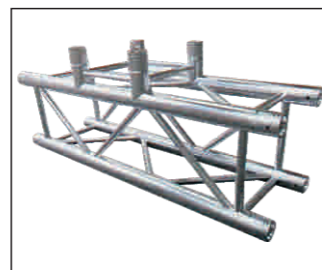

T字接头/3-way 90° Corner T



四通接头/4-way Corner



五通接头/5-way Corner



斜接头/Down Corner

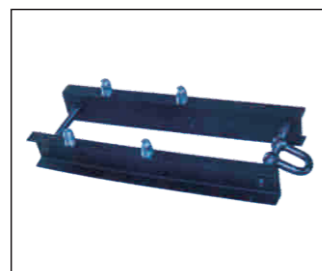

横担/Top - Section

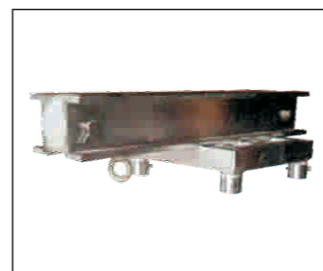

横担/Top - Section

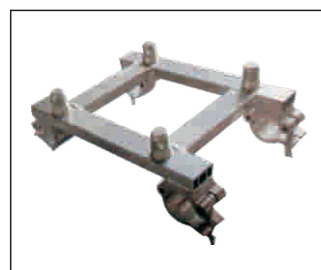

井字架/Connection-J



连接件/Connection



插销/Bolt



弹簧扣/Snap Hook

螺丝架配件 / Bolt Truss Accessories

螺丝架配件
Bolt Truss Accessories



底座/Floor

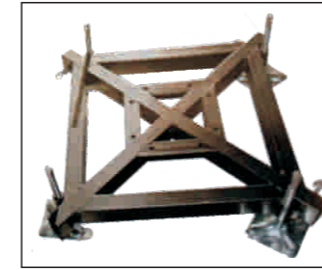

底座/Base



底座/Base

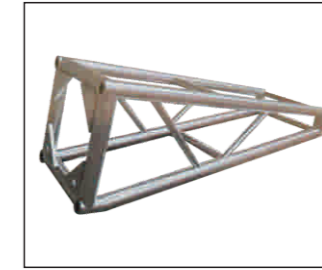

斜接头/Slant Corner

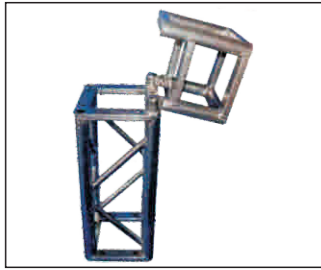

反头/Hinge



反头/Hinge

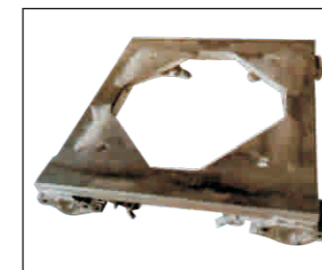

井字架/Connection-J

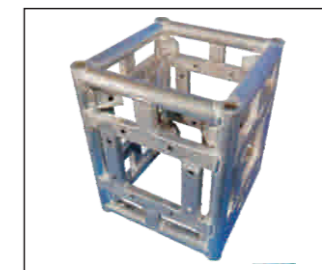

方套/Sleeve Block



方套/Sleeve Block

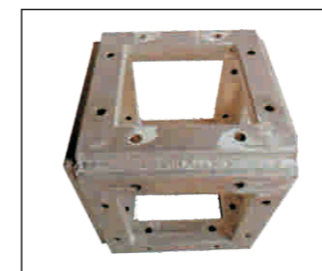

六面接头/Box Corner



六面接头/Box Corner

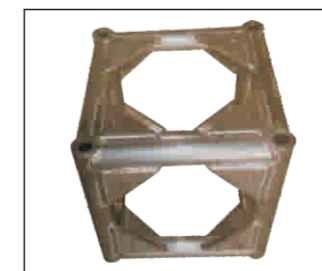

六面接头/Box Corner



活动接头/Adjustable Corner

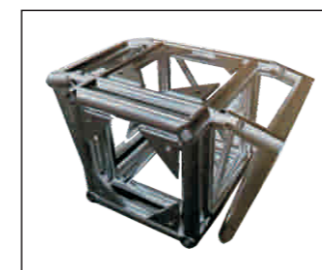

四通接头/4-way Corner

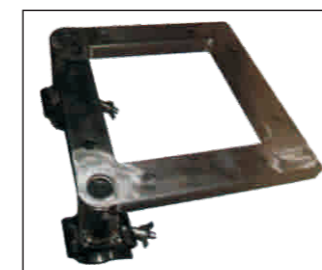

屋顶接头/Roof Corner

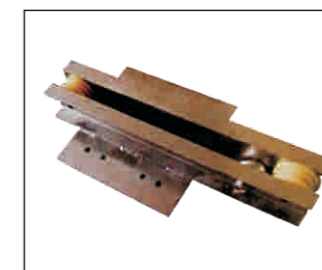

横担/Top - Section



横担/Top - Section

共用配件等 / Common Accessories



斜撑/Brace



斜撑/Brace



斜撑/Brace

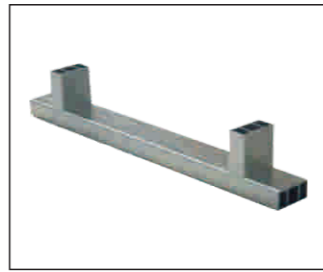

保险杠/Stopper



倒挂手拉葫芦
Handle Hoist



正挂手拉葫芦
Handle Hoist



电动葫芦/Electric Hoist

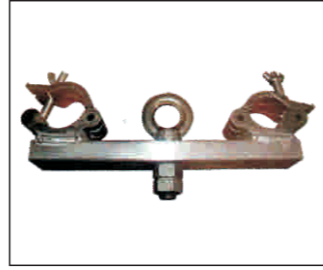

吊扣/Suspension Clasp



普通版控制器
Common version controller



豪华版控制器
Luxury Controller



吊带/Camisole



飞机带/Pull Tab



航空箱/Flightcase



航空箱/Flightcase



航空箱/Flightcase



航空箱/Flightcase



车用移动斜坡板
Mobile ramp plate for vehicles



车用移动斜坡板
Mobile ramp plate for vehicles



临时讲台
Temporary podium



立柱起柱架
Help Erecting System

灯钩系列 / Lamp hook series



型号/Model	DG-1001
产品宽度/Width	38mm
承重/Safe working load	200KGs
卡管 /Card tube	36-73mm
单重/Self weight	0.46KG
材质/Material	Al6061-T6



型号/Model	DG-1002
产品宽度/Width	30mm
承重/Safe working load	100KGs
卡管 /Card tube	40-60mm
单重/Self weight	0.45KG
材质/Material	Al6061-T6



型号/Model	DG-1003
产品宽度/Width	30mm
承重/Safe working load	150KGs
卡管 /Card tube	38-52mm
单重/Self weight	0.46KG
材质/Material	Al6061-T6

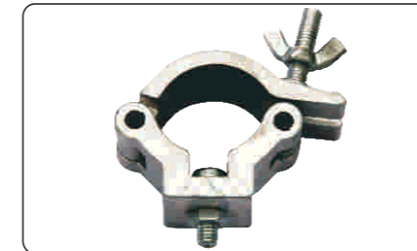

型号/Model	DG-1004
产品宽度/Width	38mm
承重/Safe working load	80KGs
卡管 /Card tube	45-52mm
单重/Self weight	0.15KG
材质/Material	Al6061-T6



型号/Model	DG-1005
产品宽度/Width	30mm
承重/Safe working load	100KGs
卡管 /Card tube	26-32mm
单重/Self weight	0.15KG
材质/Material	Al6061-T6

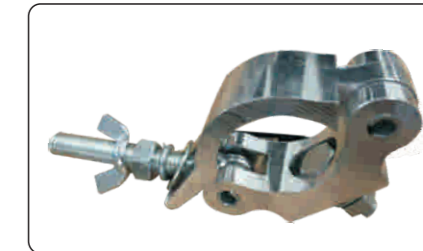

型号/Model	DG-1006
产品宽度/Width	30mm
承重/Safe working load	150KGs
卡管 /Card tube	38-52mm
单重/Self weight	0.37KG
材质/Material	Al6061-T6



型号/Model	DG-1007
产品宽度/Width	50mm
承重/Safe working load	250KGs
卡管 /Card tube	38-52mm
单重/Self weight	0.48KG
材质/Material	Al6061-T6

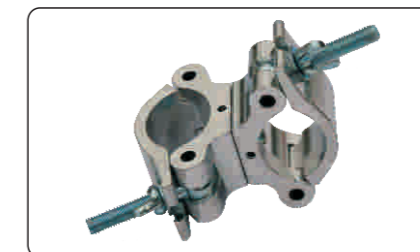

型号/Model	DG-008
产品宽度/Width	50mm
承重/Safe working load	500KGs
卡管 /Card tube	38-52mm
单重/Self weight	0.9KG
材质/Material	Al6061-T6



型号/Model	DG-1009
产品宽度/Width	30mm
承重/Safe working load	100KGs
卡管 /Card tube	40-60mm
单重/Self weight	0.47KG
材质/Material	Al6061-T6

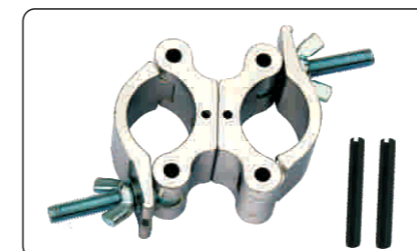

型号/Model	DG-1010
产品宽度/Width	50mm
承重/Safe working load	500KGs
卡管 /Card tube	48-62mm
单重/Self weight	1.2KG
材质/Material	Al6061-T6



型号/Model	DG-1011
管长/Director	500mm
材质/Material	Al6061-T6铝合金

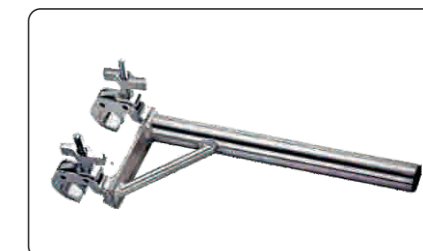

型号/Model	DG-1012
管长/Director	500mm
材质/Material	Al6061-T6铝合金

手摇架 / Lifting Truss



7米超重型支架
高度:2.5-7m
横杆:0.5m
自重:120kg
载重:340kg
底盘:2.2m
材料厚度:2.5mm
用料:方管120/100/80/60mm
包装尺寸:2450*600*450mm

GL-001



7米超重型支架
高度:2-7m
横杆:0.5m
自重:105kg
载重:250kg
底盘:2.2m
材料厚度:2.5mm
用料:方管120/100/80/60/40mm
包装尺寸:2000*550*440mm

GL-002



6米超重型支架
高度:1.9-6m
横杆:0.5m
自重:70kg
载重:250kg
底盘:2.2m
材料厚度:2.5mm
用料:方管100/80/60/40mm
包装尺寸:1900*540*420mm

GL-003



6米重型支架
高度:1.9-6m
横杆:2m
灯位:16个
自重:70kg
载重:250kg
底盘:2.2m
材料厚度:2.5mm
用料:方管100/80/60/40mm
包装尺寸:1900*540*420mm

GL-003B



4米重型支架
高度:1.8-4m
横杆:0.5m
自重:53kg
载重:200kg
底盘:2.2m
材料厚度:2.5mm
用料:方管80/60/40mm
包装尺寸:1800*520*410mm

GL-004



4米重型支架
高度:1.8-4m
横杆:2m long
灯位:16个
自重:53kg
载重:200kg
底盘:2.2m
材料厚度:2.5mm
用料:方管80/60/40mm
包装尺寸:1800*520*410mm

GL-004B



6米音响重型支架
高度:2-6m
自重:110kg
载重:250kg
底盘:2.2m
材料厚度:2.5mm
用料:方管120/100/80/60mm
包装尺寸:2000*620*500mm

GL-005

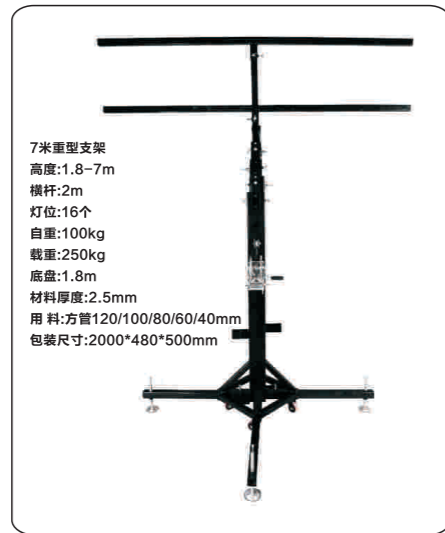

7米重型支架
高度:1.8-7m
横杆:2m
灯位:16个
自重:100kg
载重:250kg
底盘:1.8m
材料厚度:2.5mm
用料:方管120/100/80/60/40mm
包装尺寸:2000*480*500mm

GL-006B



6米重型支架
高度:1.9-6m
横杆:0.5m
自重:70kg
载重:250kg
底盘:1.8m
材料厚度:2.5mm
用料:方管100/80/60/40mm
包装尺寸:1900*460*460mm

GL-007

手摇架 / Lifting Truss



6米重型支架
高度:1.9-6m
横杆:2m
灯位:16个
自重:70kg
载重:250kg
底盘:1.8m
材料厚度:2.5mm
用料:方管100/80/60/40mm
包装尺寸:1900*460*460mm

GL-007-B



4米重型支架
高度:1.8-4m
横杆:0.5m
自重:50kg
载重:200kg
底盘:1.8m
材料厚度:2.5mm
用料:方管80/60/40mm
包装尺寸:1800*450*450mm

GL-008



4米重型支架
高度:1.8-4m
横杆:2m
灯位:16个
自重:50kg
载重:200kg
底盘:1.8m
材料厚度:2.5mm
用料:方管80/60/40mm
包装尺寸:1800*450*450mm

GL-008-B



4米中型支架
高度:1.8-4m
横杆:0.5m
自重:36kg
载重:100kg
底盘:1.8m
材料厚度:1.2mm
用料:方管60/40mm
圆管35mm
包装尺寸:1800*450*450mm

GL-009

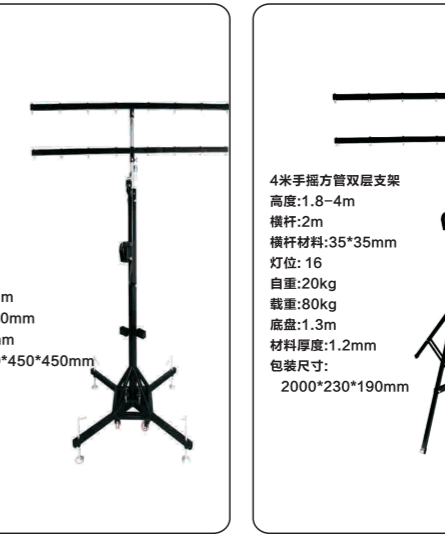

4米中型支架
高度:1.8-4m
横杆:2m
灯位:16个
自重:36kg
载重:100kg
底盘:1.8m
材料厚度:1.2mm
用料:方管60/40mm
圆管35mm
包装尺寸:1800*450*450mm

GL-009-B



4米手摇方管双层支架
高度:1.8-4m
横杆:2m
横杆材料:35*35mm
灯位:16个
自重:20kg
载重:80kg
底盘:1.3m
材料厚度:1.2mm
包装尺寸:
2000*230*190mm

GL-010



4米手摇方管单层支架
高度:1.8-4m
横杆:2m
横杆材料:35*35mm
灯位:8个
自重:18.5kg
载重:80kg
底盘:1.3m
材料厚度:1.2mm
包装尺寸:
2000*230*190mm

GL-010-B



4米手摇圆管双层支架
高度:1.8-4m
横杆:2m
横杆材料:48mm
自重:21kg
载重:80kg
底盘:1.3m
材料厚度:1.2mm
包装尺寸:
2000*230*190mm

GL-011



4米手摇圆管单层支架
高度:1.8-4m
横杆:2m
横杆材料:48mm
自重:19kg
载重:80kg
底盘:1.3m
材料厚度:1.2mm
包装尺寸:
2000*230*190mm

GL-011-B



4米手摇短杆支架
高度:1.8-4m
横杆:1.5m
横杆材料:45*45mm
自重:19kg
载重:80kg
底盘:1.3m
材料厚度:1.2mm
包装尺寸:
1800*230*190mm

GL-012

3米手摇方管单层支架
高度:1.8-3m
横杆:1.5m
横杆材料:35*35mm
灯位:6个
自重:14kg
载重:60kg
底盘:1.3m
材料厚度:1.2mm
包装尺寸:
1800*230*190mm

GL-013

异型灯光架 / Arched Truss

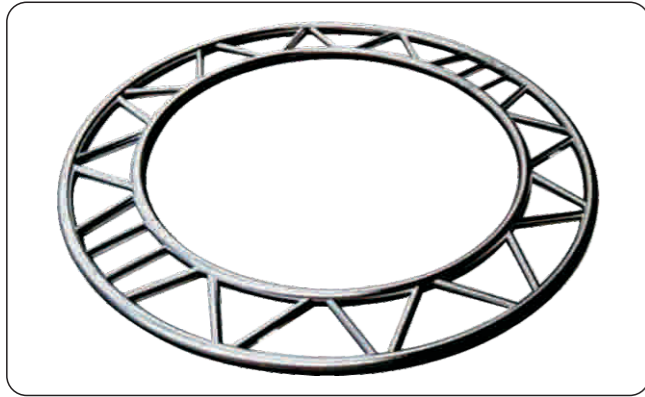

单排圆/Flat Circle Horizontal

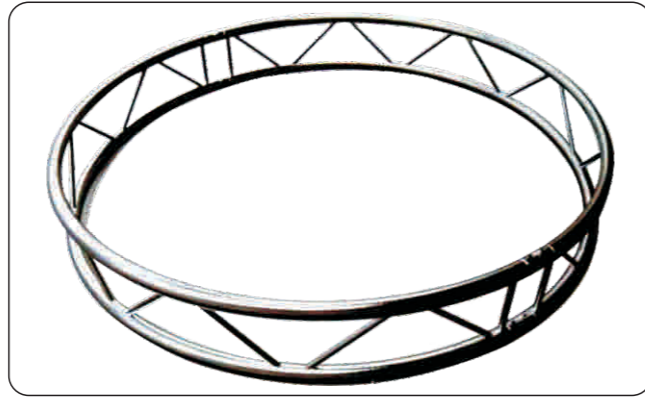

单排圆/Flat Circle Vertical

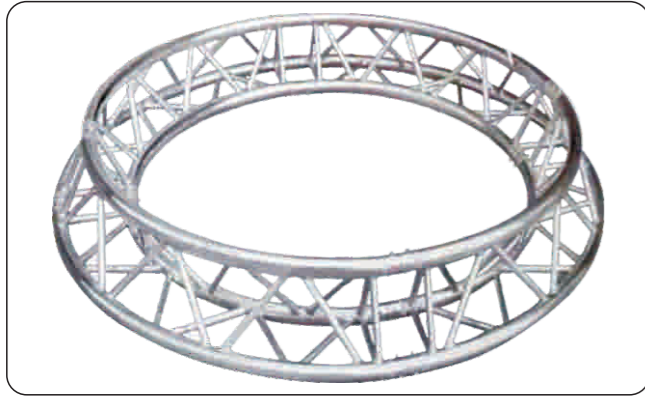

三角圆架/Triangular Circle

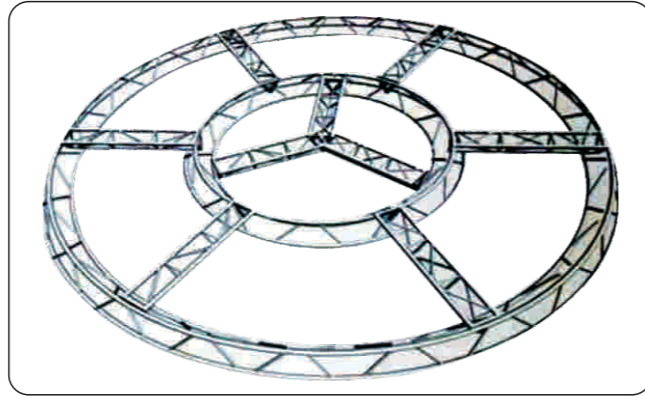

多圆组合架/Compliance Circle

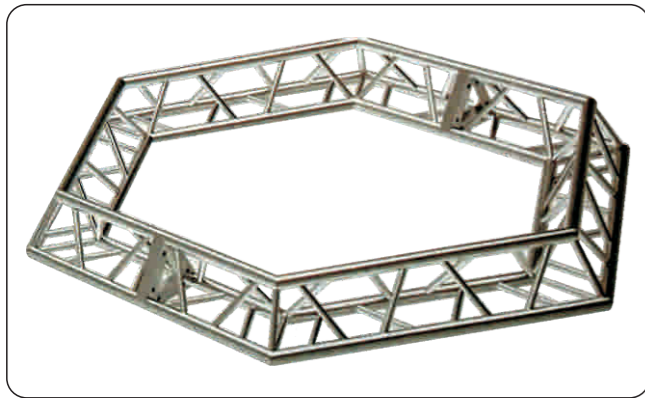

六角型架/Hexagonal Circle

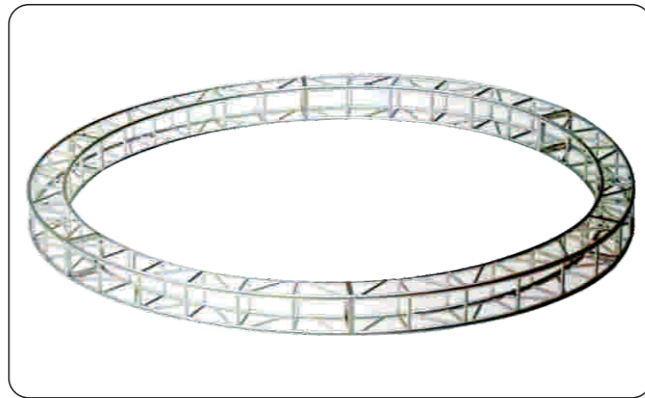

四方型架/Square Circle

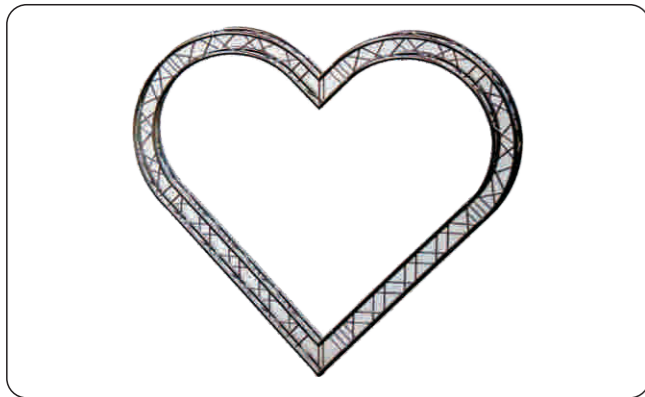

心型架/Heart-shaped Truss



五角星架/Five-Pointed Star

铝合金脚手架 / Aluminum Scaffold

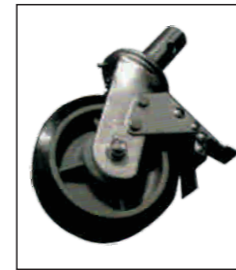
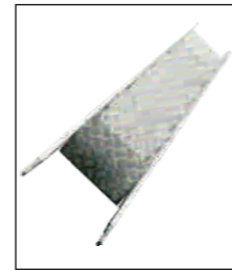

常规尺寸: 1830*1476*1800mm

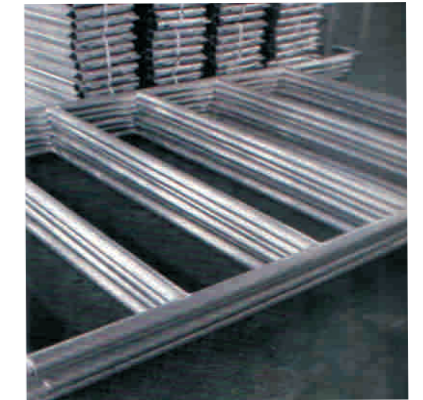

简易舞台 / Portable Stage

- 1.此舞台由可调节底座、舞台升降管、舞台立柱、舞台单片、舞台面组成，搭建拆装方便，外观美观；
- 2.台面有多种材料，防滑防水木板、有机玻璃、玻璃等；
- 3.舞台规格可以根据可以要求定制；
- 4.舞台护栏、楼梯可以定制；
- 5.舞台承重：800kg/m²(1220x1220mm)；400kg/m²(1220x2440mm)

1. This kind of stage consist of adjustable base, extendable base, extendable tube, stage, stane stage brace, stage topping. it is easy to assemble and adjustable Aesthetic shape
2. there are many kinds of stage topping for your choosing Such as, waterproof non-slip Wood, organic glass, etc.
3. We can provide customized strikes accordind to client reupirement;
4. There are many other stage accessories to math the stage Like stage baluster, aluminium stair
5. Load capacity: 800kg/m²(1220x1220mm) ; 400kg/m²(1220x2440mm)

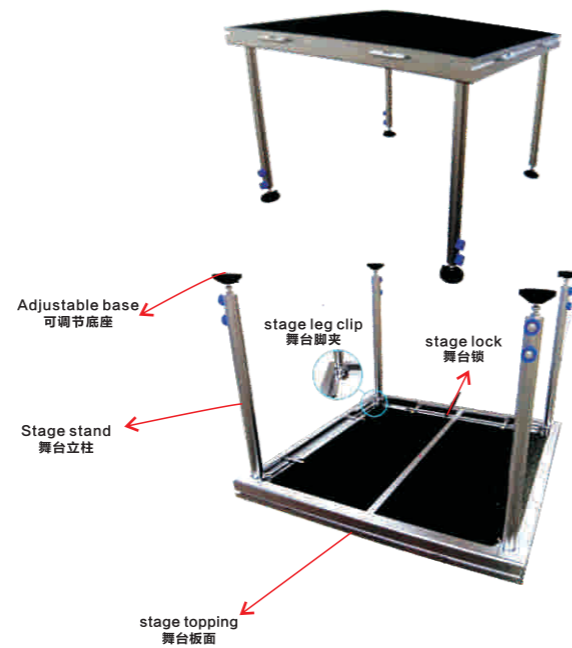

舞台规格/Stage size



GL-P122

SIZE:1220*1220MM



GL-P244

SIZE:1220*2440MM

连杆舞台 / Connecting Rod Stage



- 1.此舞台由可调节底座、舞台升降管、舞台立柱、舞台单片、舞台面组成，搭建拆装方便，外观美观；

- 2.台面有多种材料，防滑防水木板、有机玻璃、玻璃等；
- 3.舞台规格可以根据可以要求定制；
- 4.舞台护栏、楼梯可以定制；
- 5.舞台承重：780kg/m²(1220x1220mm); 450kg/m²(1220x2440mm)

1. This kind of stage consist of adjustable base, extendable base, extendable tube, stage, stane stage brace, stage topping. it is easy to assemble and adjustable Aesthetic shape
2. there are many kinds of stage topping for your choosing Such as, waterproof non-slip Wood, organic glass, etc.
3. We can provide customized strikes accordind to client reupirement;
4. There are many other stage accessories to math the stage Like stage baluster, aluminium stair
5. Load capacity: 780kg/m²(1220x1220mm); 450kg/m²(1220x2440mm)



舞台规格/Stage size



GL-N122

SIZE:1220*1220MM



GL-N244

SIZE:1220*2440MM

铝合金拼装舞台/Aluminium Assembly Stage

- 1.此舞台由可调节底座、舞台升降管、舞台立柱、舞台单片、舞台面组成，搭建拆装方便，外观美观；
- 2.台面有多种材料，防滑防水木板、有机玻璃、玻璃等；
- 3.舞台规格可以根据客户要求定制；
- 4.舞台护栏、楼梯可以定制；
- 5.舞台承重：780kg/m²(1220x1220mm)；450kg/m²(1220x2440mm)

- 1.This kind of stage consist of adjustable base,extendable base,extendable tube,stage,stage stage brace, stage topping.it is easy to assemble and adjustable Aesthetic shape
- 2.there are many kinds of stage topping for your choosing Such as,waterproof non-slip Wood,organic glass, etc.
- 3.We can provide customized strikes accordind to client reupirement;
- 4.There are many other stage accessories to math the stage Like stage baluster,aluminium stair
- 5.Load capacity:780kg/m²(1220x1220mm)；450kg/m²(1220x2440mm)



舞台规格/Stage size



GL-Y122

SIZE:1220*1220MM



GL-Y244

SIZE:1220*2440MM

铝合金拼装舞台/Aluminium Assembly Stage

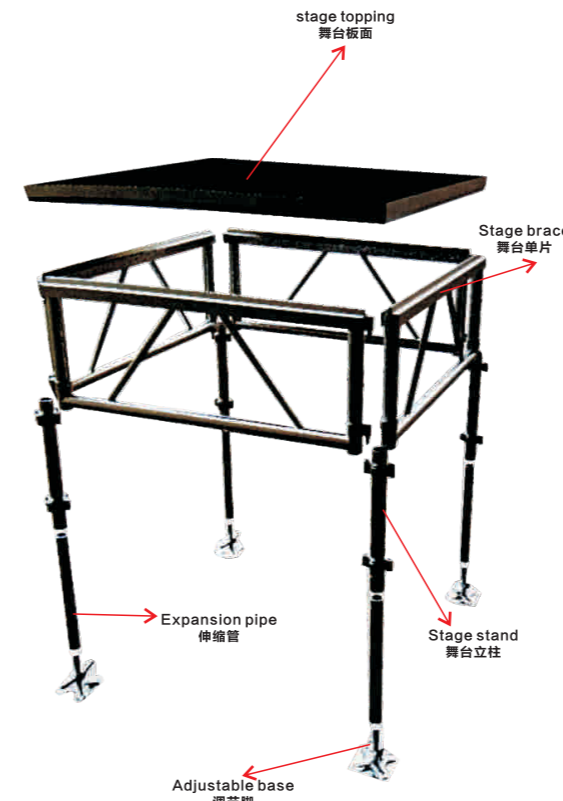

GF-122 1120*1220mm Aluminium assembly stage

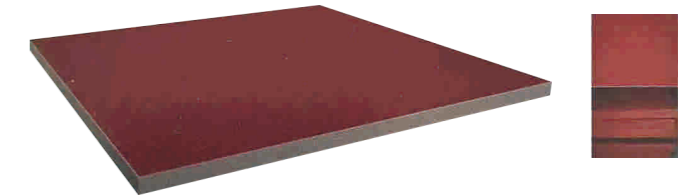

stage topping(skid-resistant surface waterproof 18mm plywood)
舞台板面 (18mm防滑防水胶板)

GF-244 1220*2440mm Aluminium assembly stage

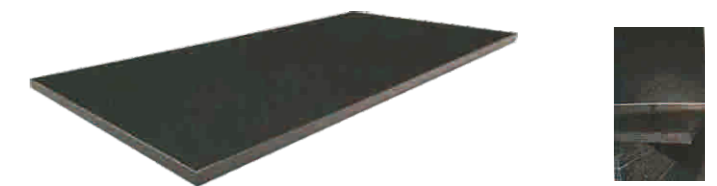

stage topping(skid-resistant surface waterproof 18mm plywood)
舞台板面 (18mm防滑防水胶板)

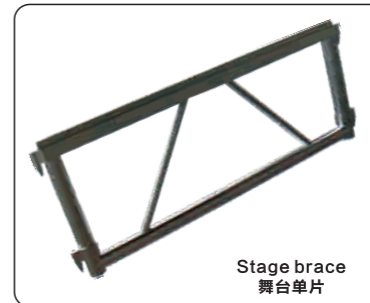

Stage brace
舞台单片

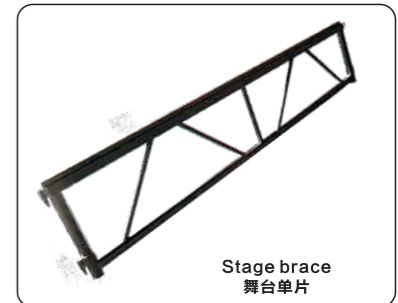

Stage brace
舞台单片



Stage stand&Expansion pipe
舞台立柱&伸缩管



Adjustable base
调节脚



Stage stair
舞台楼梯

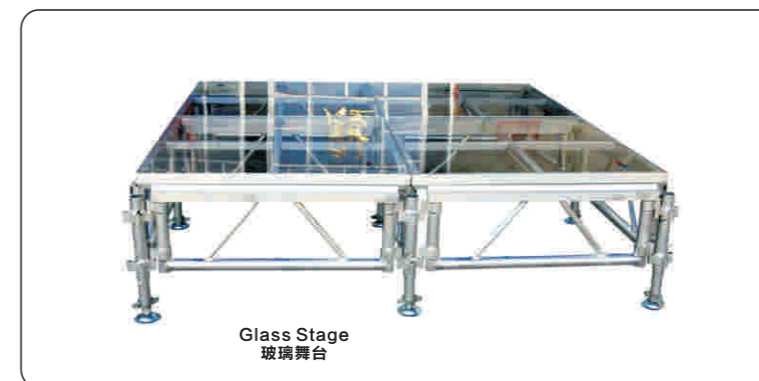

Glass Stage
玻璃舞台



LED Dancging floor
LED台板

桁架搭建展示图/ Truss structre display

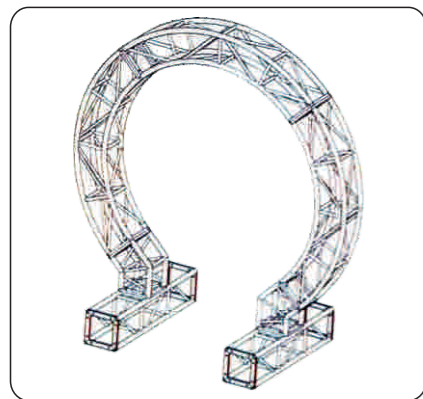

ZX-001

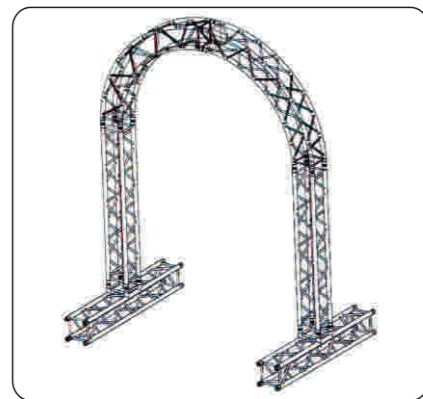

ZX-002



ZX-003

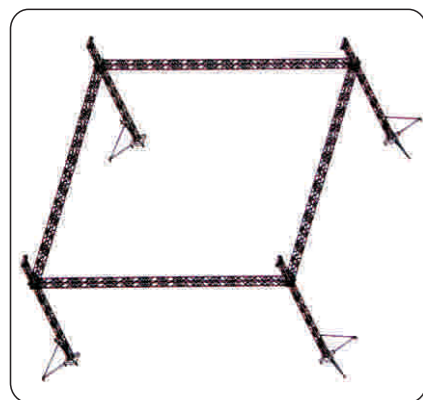

ZX-004

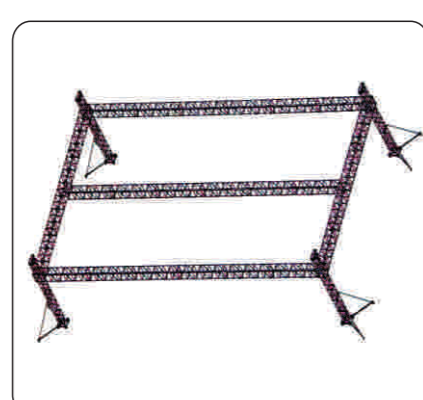

ZX-005

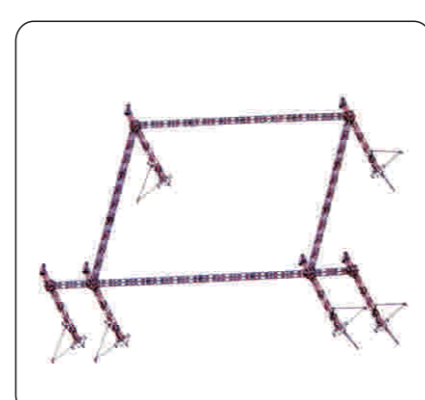

ZX-006

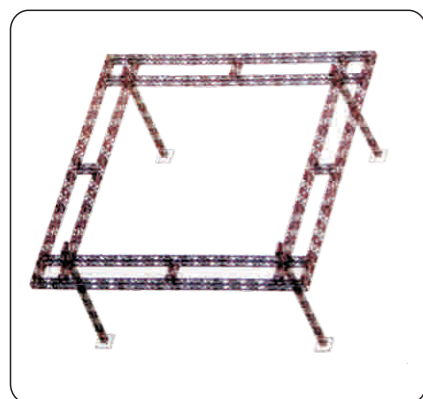

ZX-007

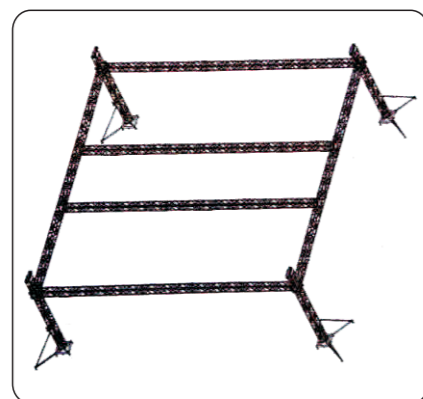

ZX-008

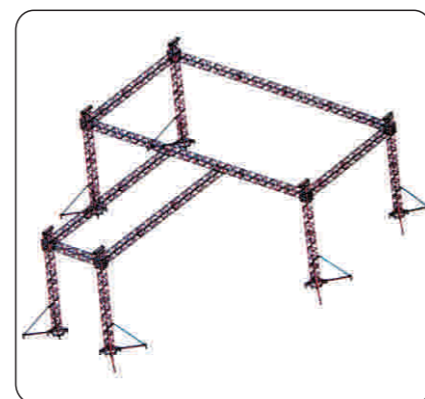

ZX-009

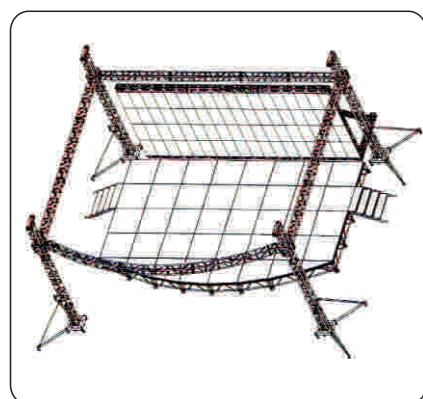

ZX-010

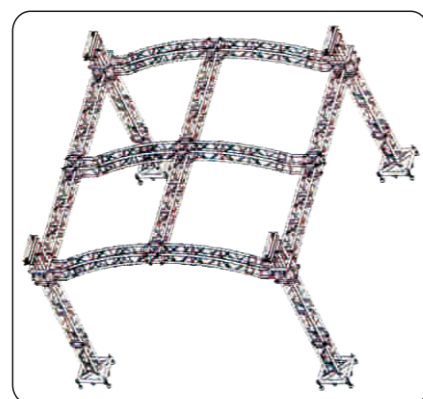

ZX-011

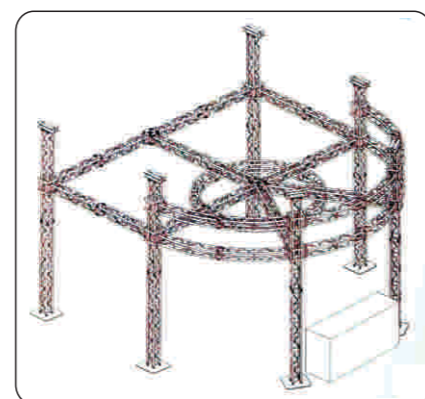

ZX-012

桁架搭建展示图/ Truss structre display

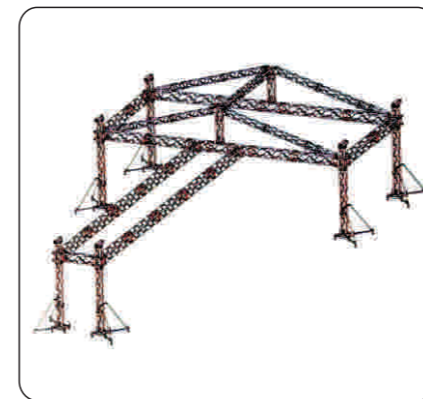

ZX-013

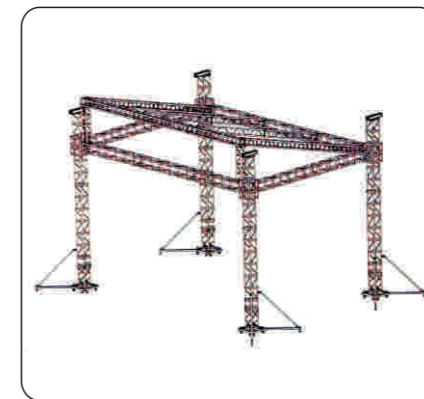

ZX-014

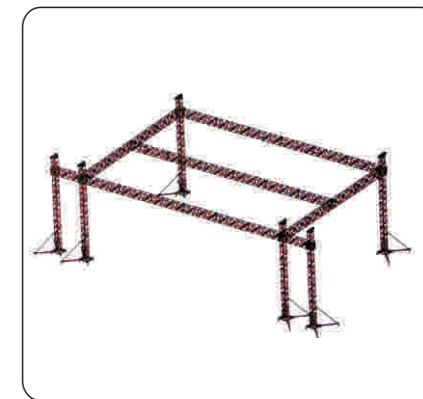

ZX-015

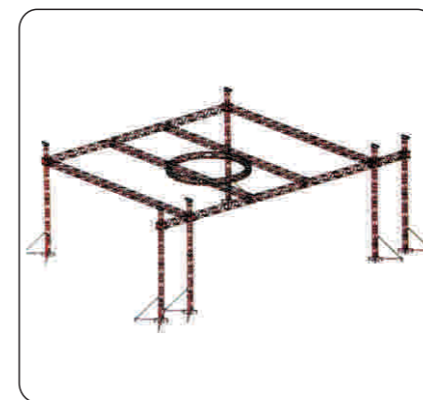

ZX-016

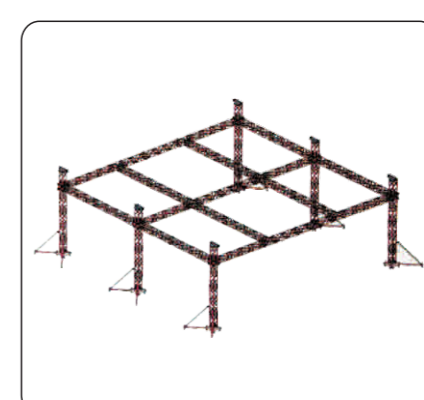

ZX-017

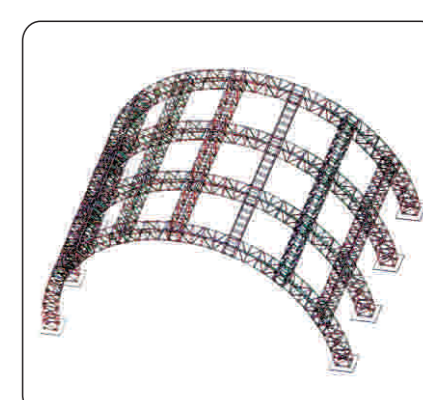

ZX-018

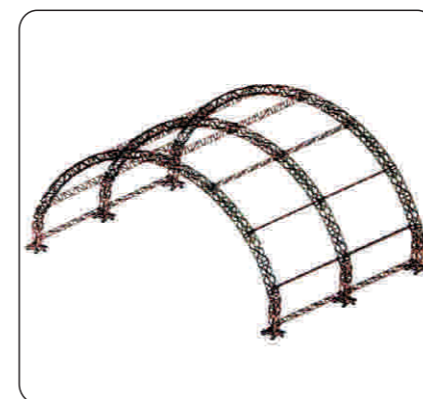

ZX-019

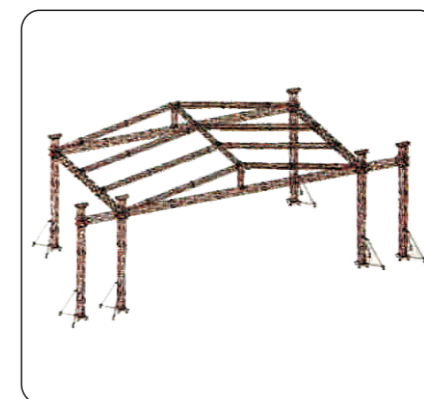

ZX-020

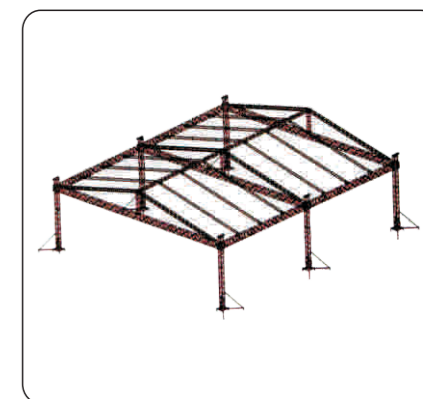

ZX-021

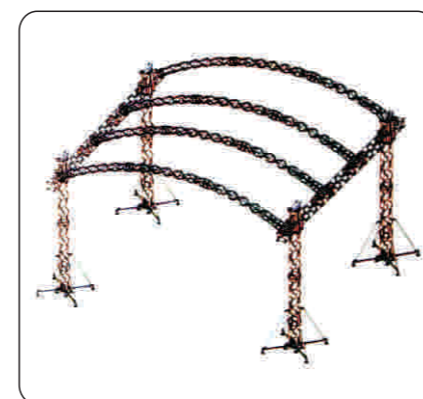

ZX-022



ZX-023

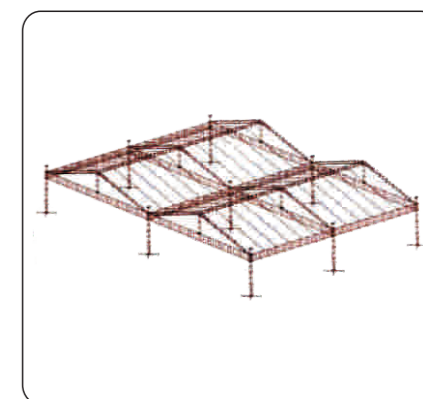

ZX-024

桁架细节展示图/Show details for truss system

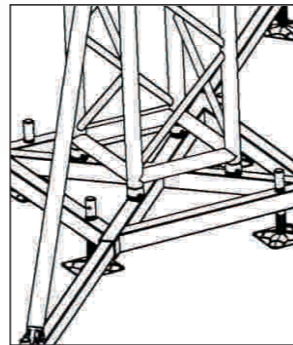
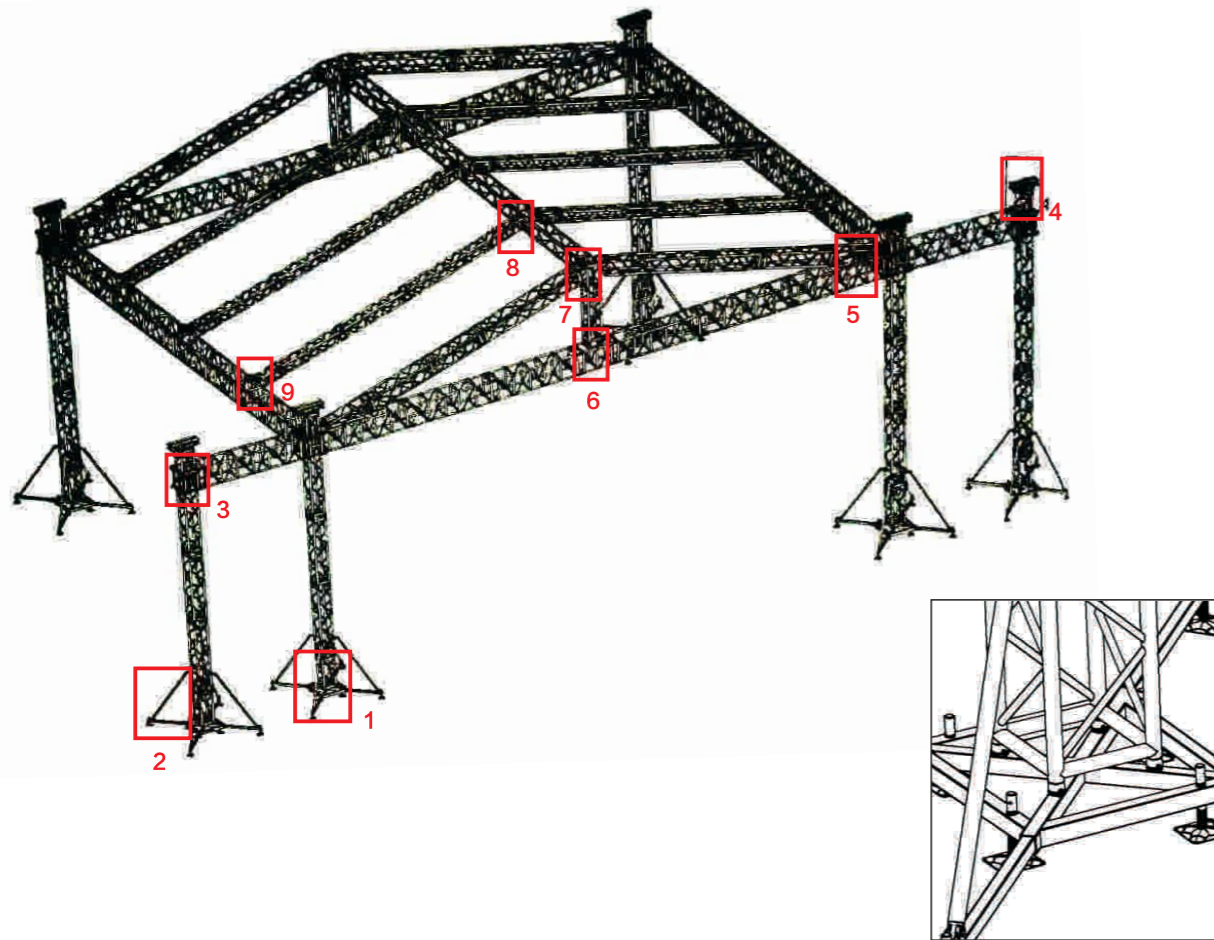

1.底座/Base

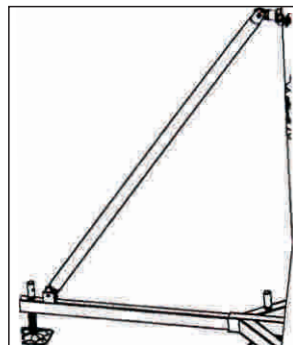

2.斜撑/Brace

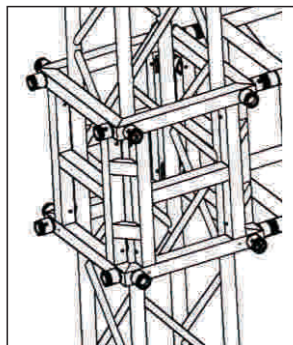

3.方套/Sleeve Block

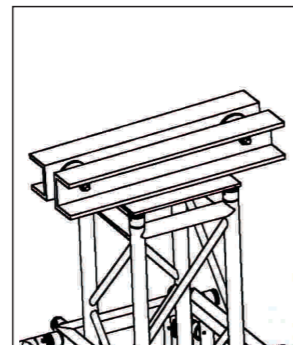

4.横担/Top-Section

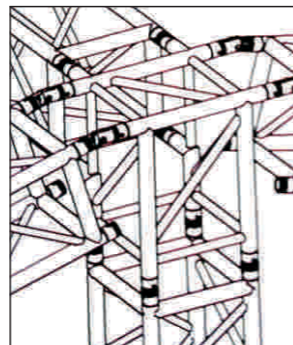

5.下接头/Down Corne

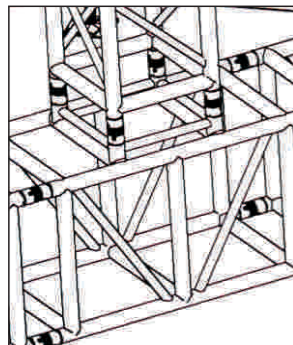

6.T字接头/T Corner

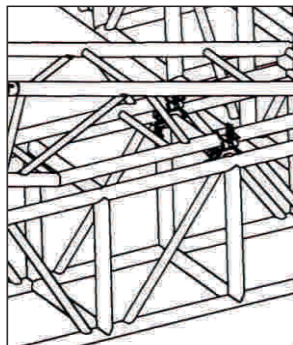

7.四通接头/4-way Corner

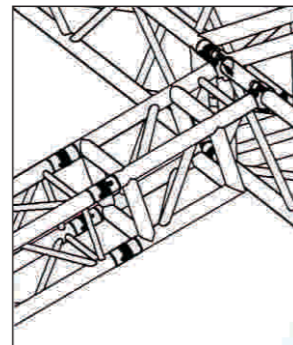

8.顶梁接头/Roof Top Corner

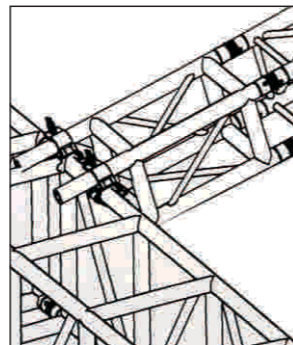

9.顶梁接头/Roof down Corner

桁架细节展示图/Show details for truss system

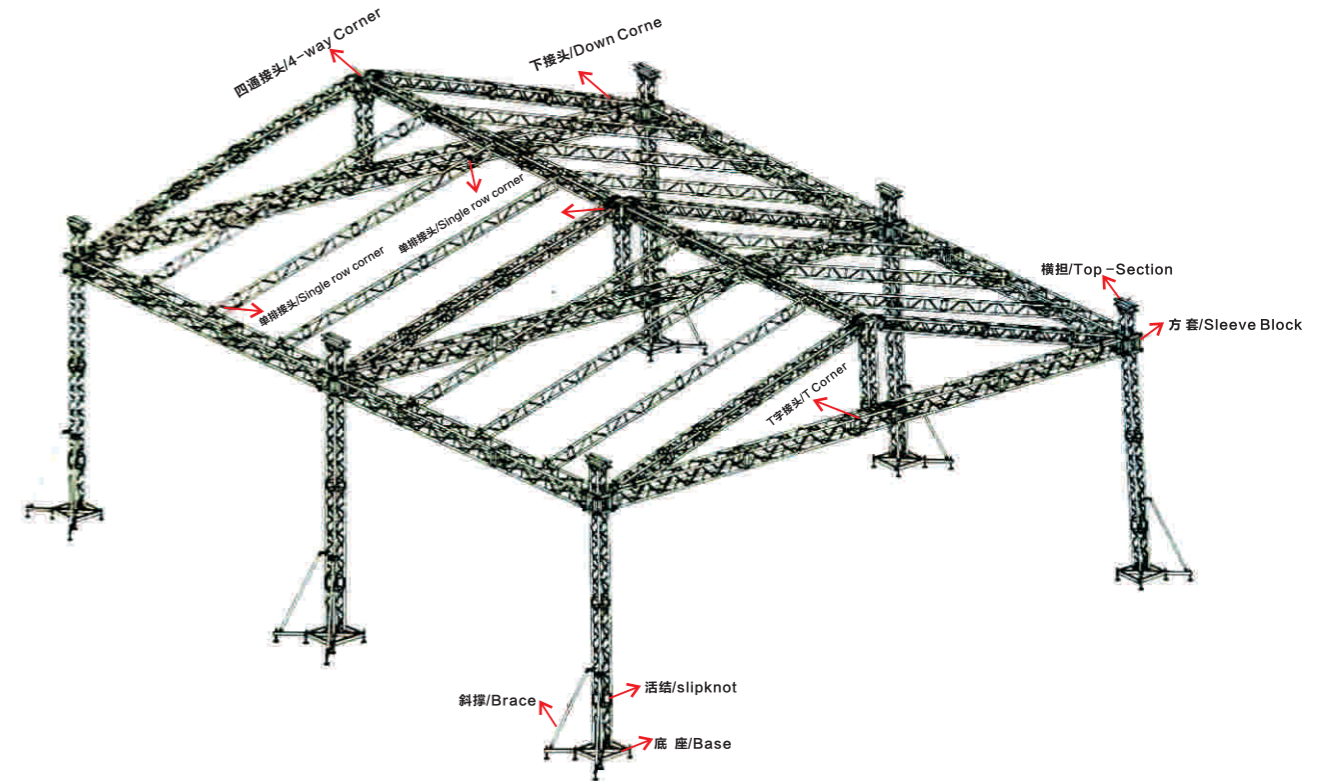

斜撑/Brace
活结/slipknot
底座/Base

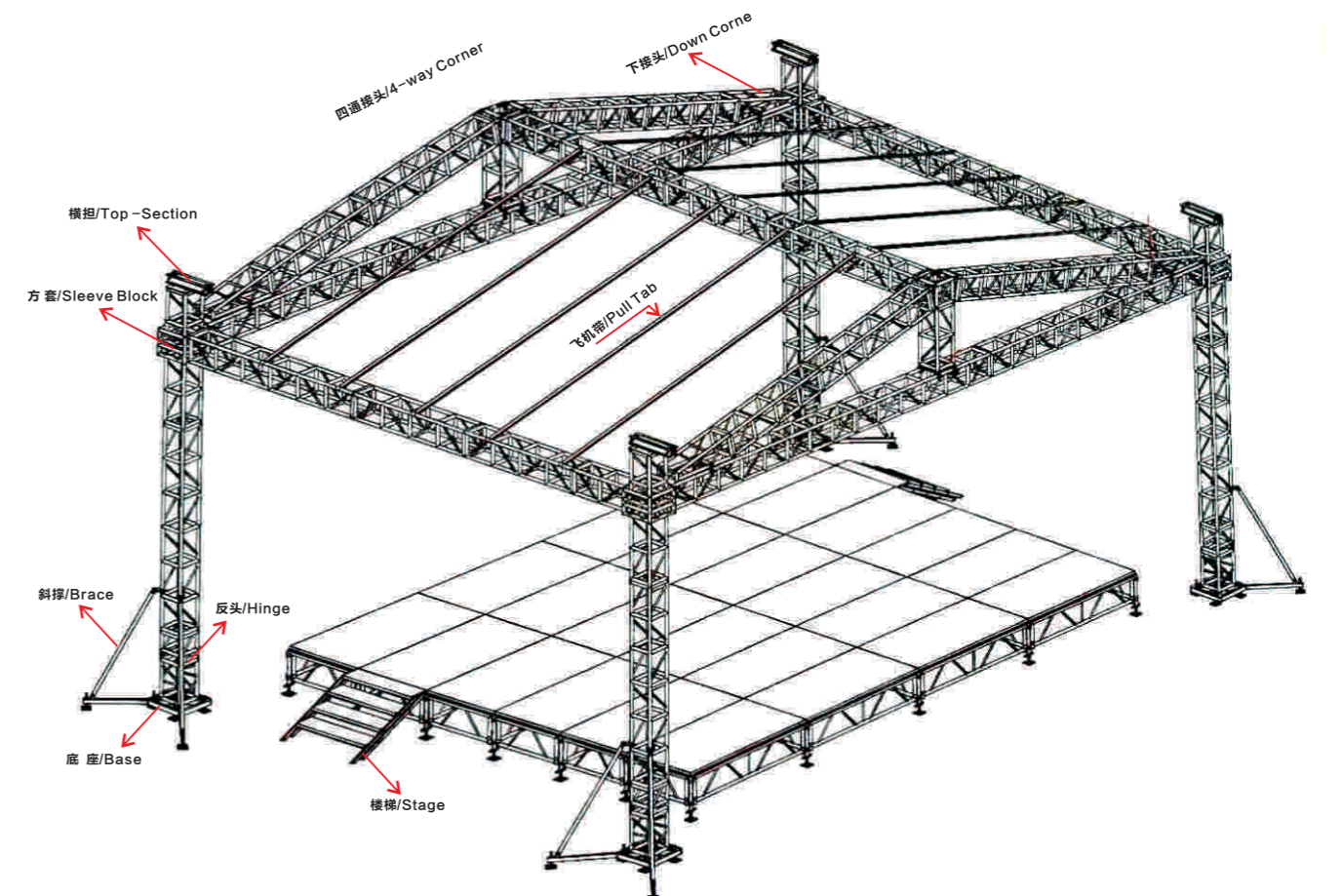

四通接头/4-way Corner
下接头/Down Corne
横担/Top-Section
方套/Sleeve Block
飞机带/Pull Tab
斜撑/Brace
反头/Hinge
底座/Base
楼梯/Stage

A字架/Audio Towers

我们不仅能够生产灯光架，同时我们也可以根据客户的要求订做各种规格的音响吊架。

We can not only make the light truss but also can make the Audio truss in different styles.

All the tower are of heavy duty ,which can load differently according to the customers ' requests.

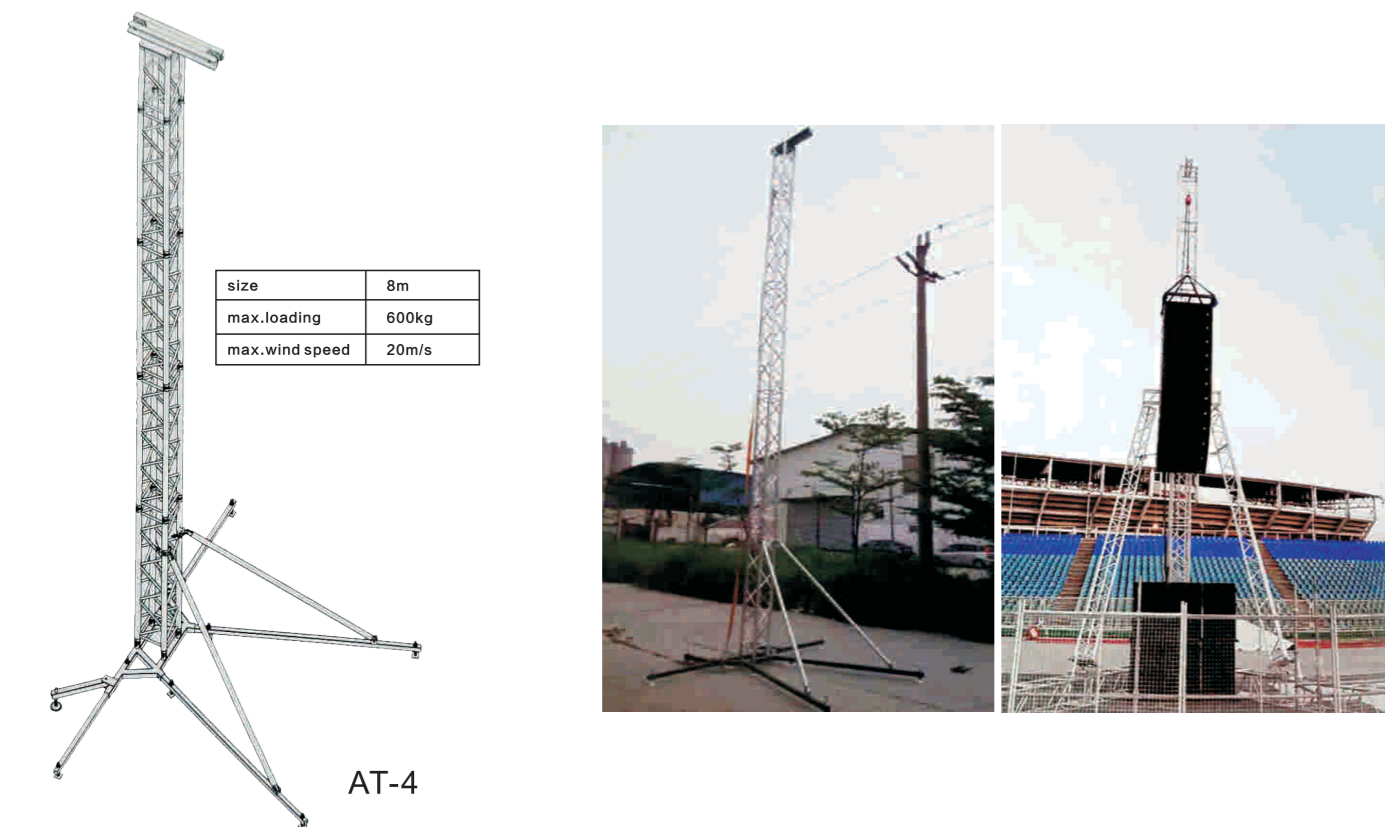
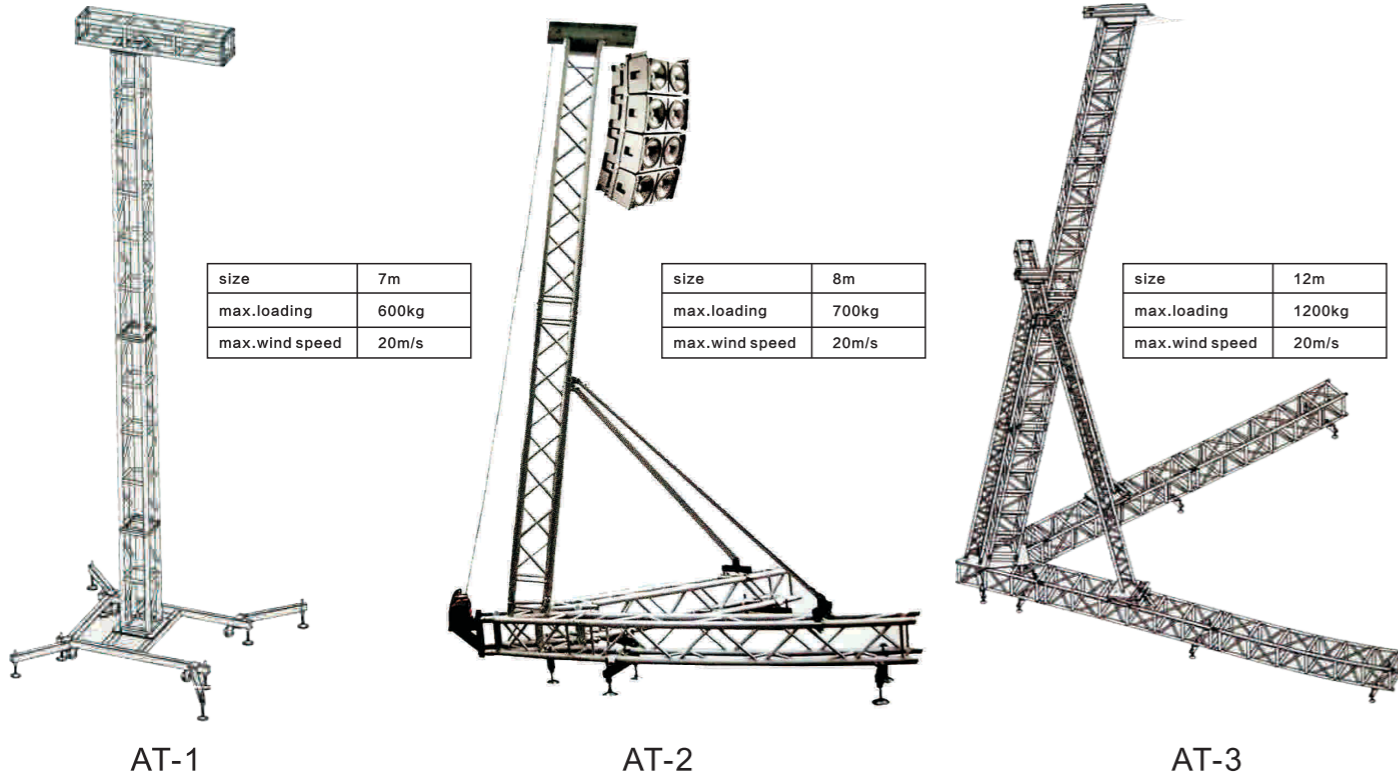

龙门架 / Portal Frame

我们不仅能够生产灯光架，同时我们也可以根据客户的要求订做各种规格的音响吊架。

We can not only make the light truss but also can make the Audio truss in different styles.

All the tower are of heavy duty ,which can load differently according to the customers ' requests.

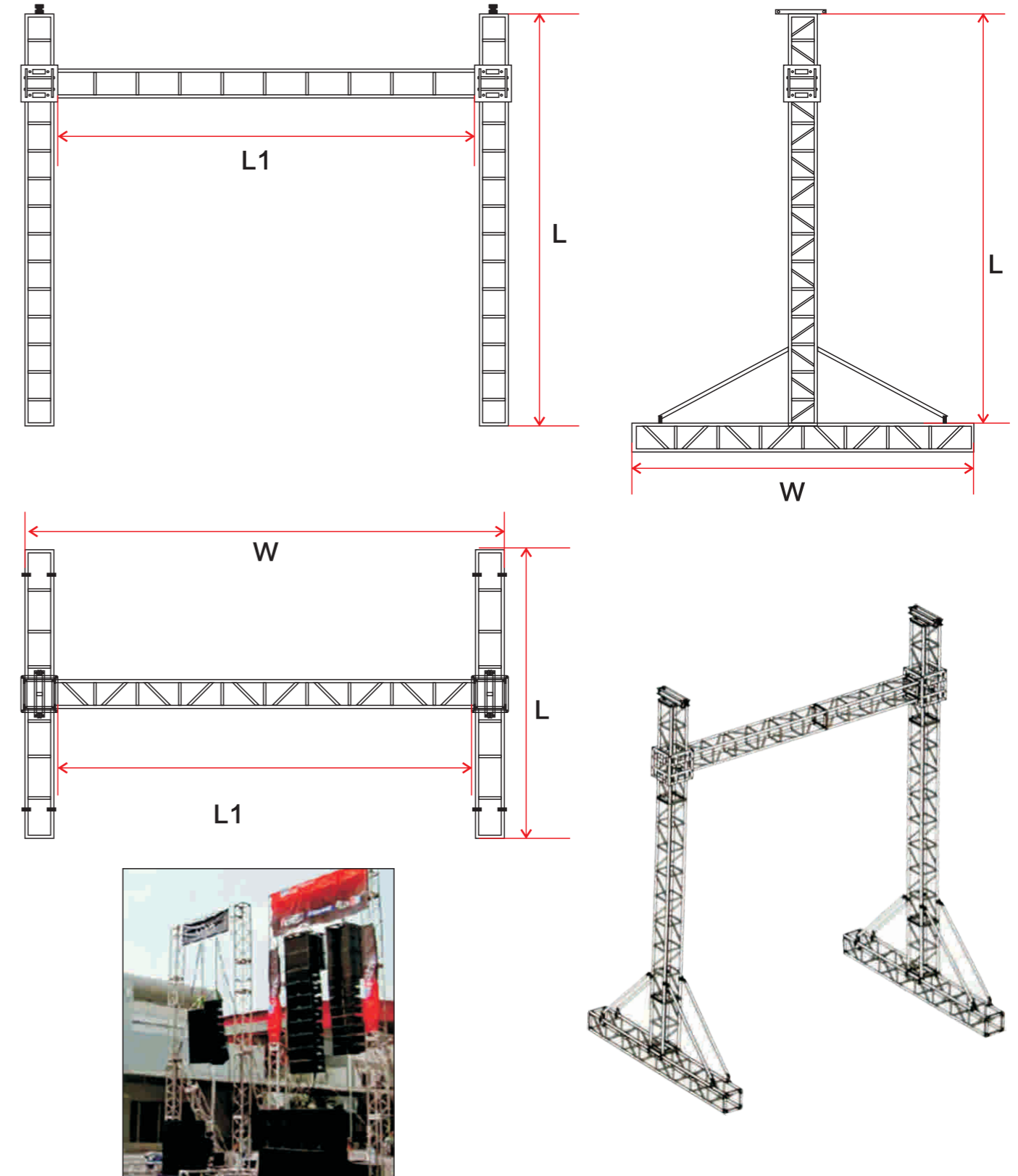

防爆栏/crowed barricade

在演出过程中所有的观众总是喜欢往前面拥挤，特别是对演员的安全有很大的危险性，靠工作人员很难维持秩序，这款防暴栏可有效的把观众与舞台及把外界与演出现场隔离减少意外发生。

All the audience always like in the front of the crowd when in the process of the performance, it will be caused security and difficult to rely on personnel to maintain order, this type of audience isolation guardrail can effectively the audience.



防爆栏/crowed barricade

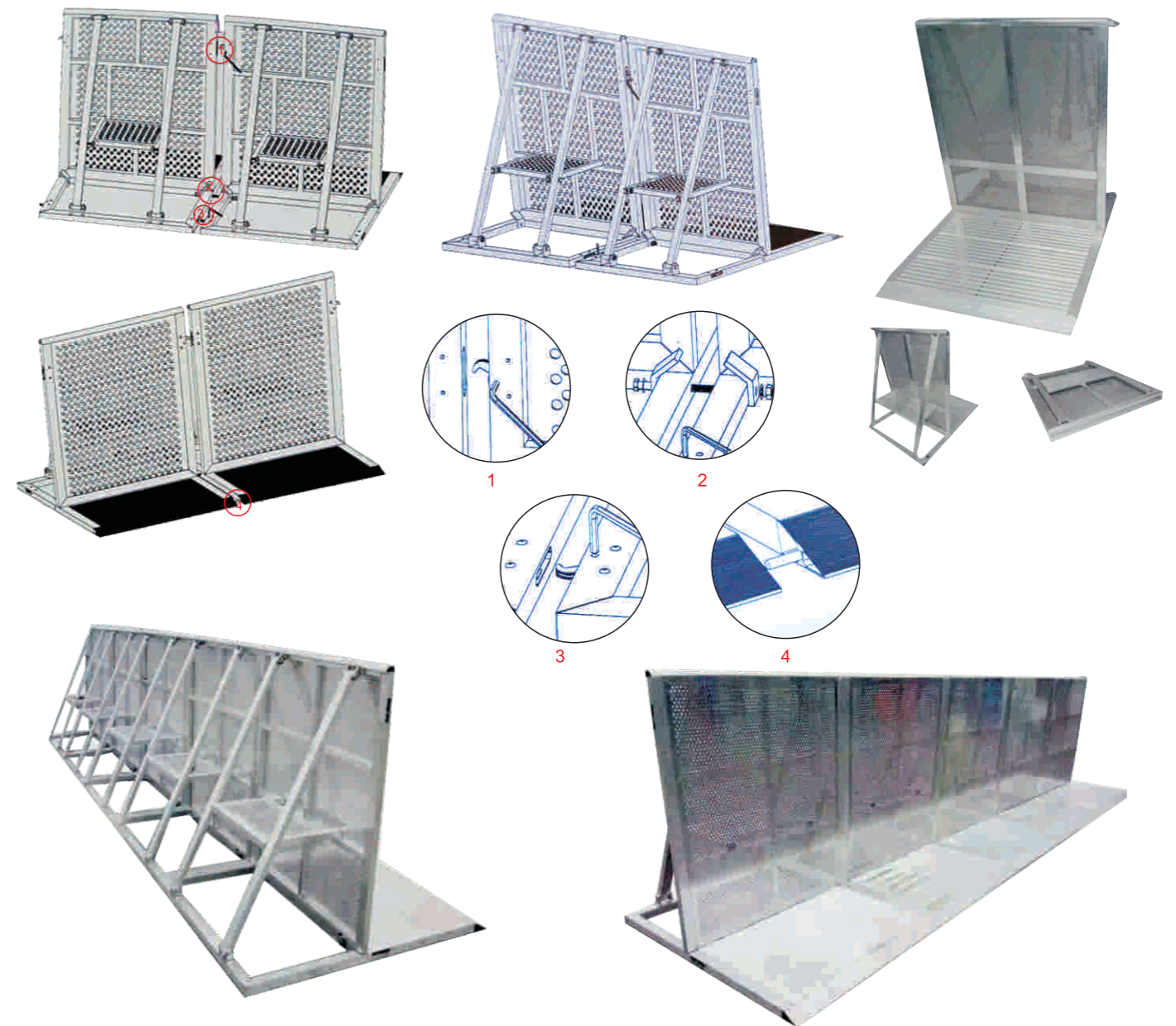

灯光展示架 / Light Show Truss Assembly

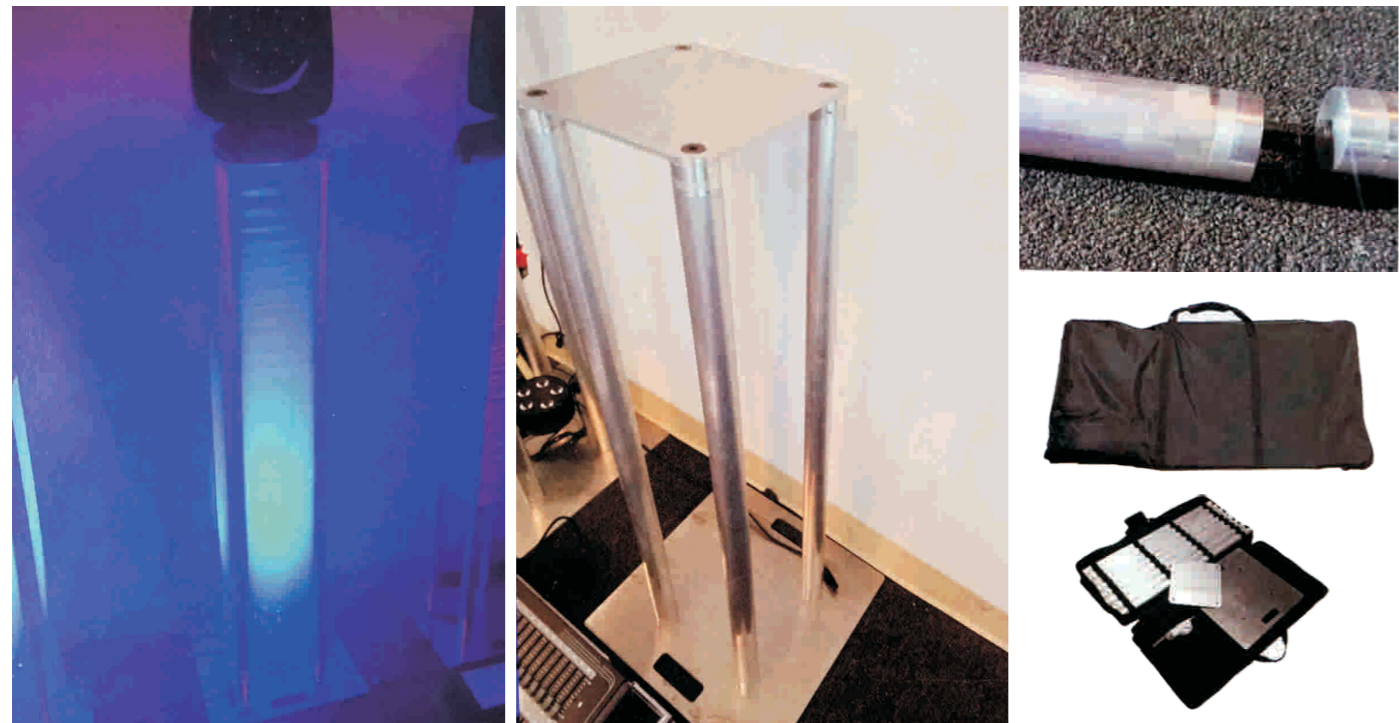

折叠合唱台 / Folding Chorus Station

全铝合金折叠合唱台，每层深370mm,有三层，四层，每层高度250mm·含护栏，带轮子
 All-aluminum alloy folding choral table, Depth 370mm per floor ,There are three layers, four stories, each with a height of 250mm, Containing guardrail, With wheels



- ◆ 1220mm长，有每层宽400mm，每层高300mm/1220mm (L) 400mm(W)per layer, 300mm(H) per layer
- ◆ 护栏：50管*2mm厚，长1220mm高600mm 中间用25管2mm厚 / 50*2mm,25*2mm, 1220mm(L)*600mm(H)
- ◆ 支柱：50管*3mm厚，中间用30管*2mm厚 / support: 50*3mm, 30*2mm
- ◆ 斜梁：50*25*3mm厚：50*25mm加厚，方管，面板：防滑防水板
 Oblique beam 50 *25mm *3mm,50mm *25mm, panel: antiskid waterproof board
- ◆ 每层可站4人/4 persons per floor



折叠合唱台 / Folding Chorus Station

折叠合唱台，支架材质是铁管，板面18mm多层板，表面采用5MM防火纤维地毯(颜色有多种可供选择)，三个层面可以拆换变动(直，弧)

Folding chorus station The scaffold is made of iron, Panel 18mm board, Surface of 5mm fire-resistant fiber carpet (colors are available), Level 3 or 4, plate can be removed and changed (straight, arc)



H-03

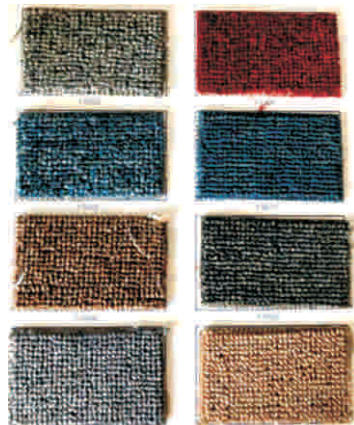
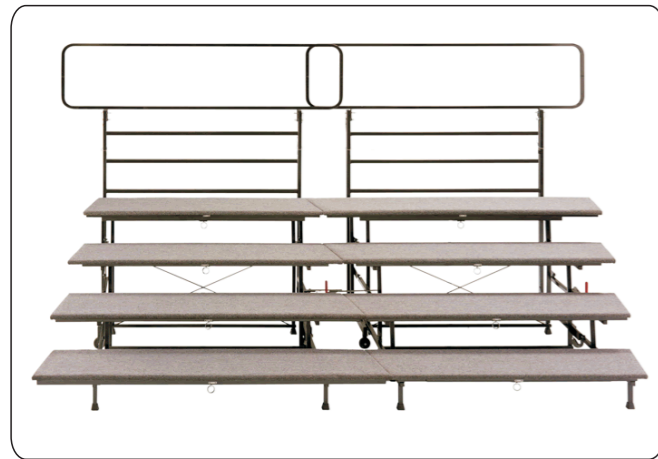

板面采用实际尺寸分为

The plate is divided into actual dimensions

一步长(L)1557-1422mm X宽(W)457mm X高(H)200mm

二步长(L)1557-1694mm X宽(W)457mm X高(H)200mm

三步长(L)1694-1841mm X宽(W)457mm X高(H)200mm

折叠合唱台 / Folding Chorus Station



H-05



指挥台/podium

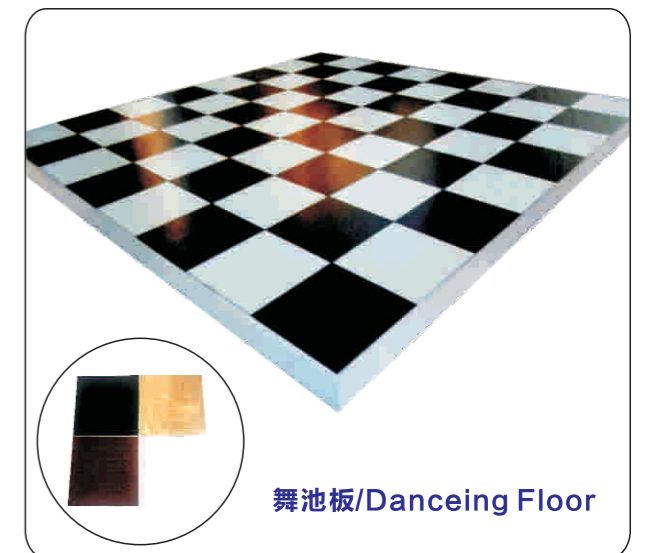
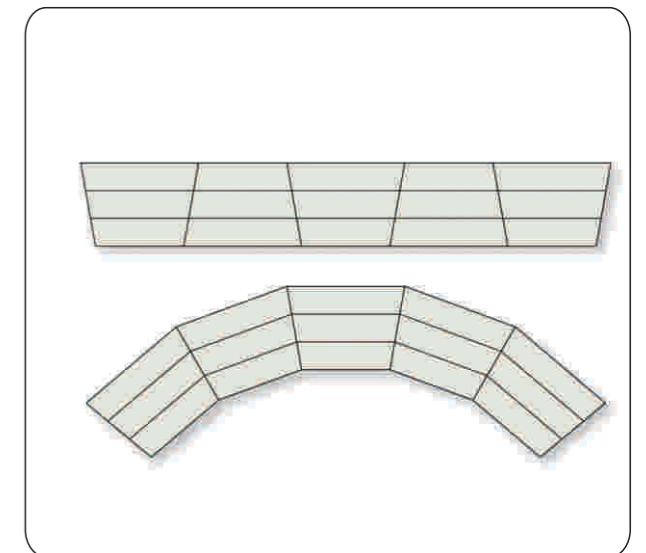

舞池板/Dancing Floor

步梯 / Steprise



1



2



3



4



5



6



7



10



8

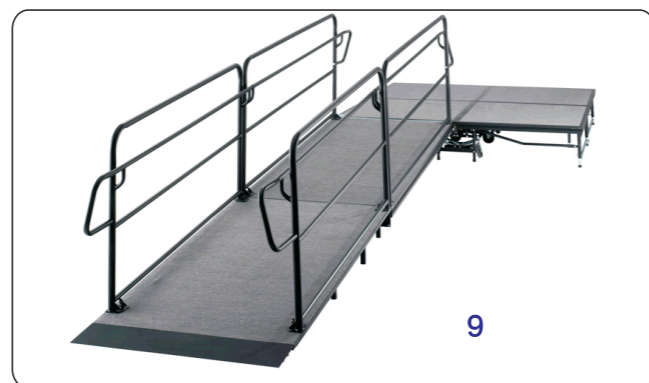

9

折叠舞台/Folding stage

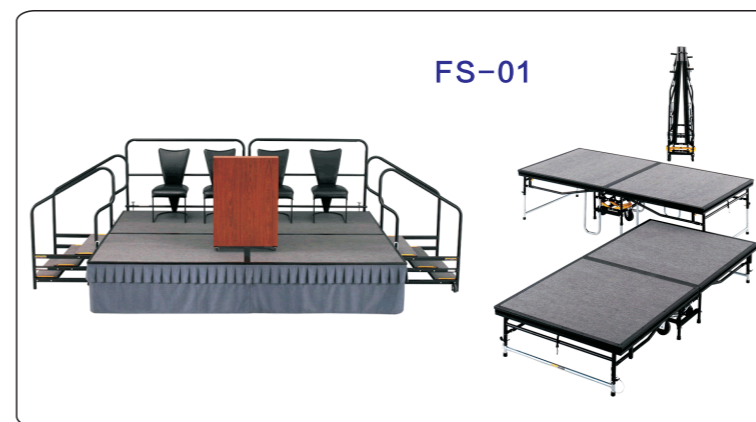

FS-01



FS-02

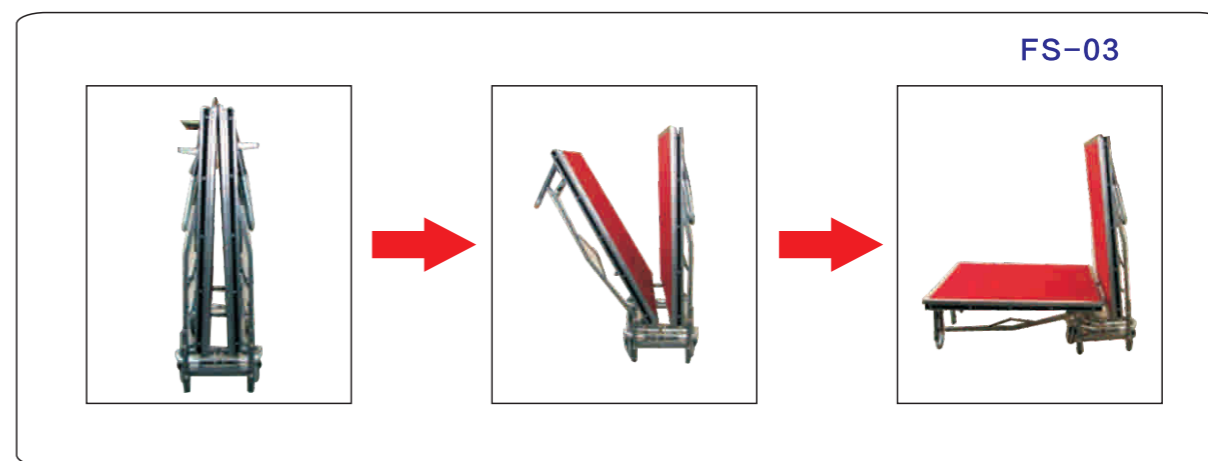

FS-03



FS-05

折叠舞台/Folding stage

◆1220(W)×2440(D)×410(H)-610(H)MM

◆1220(W)×2440(D)×610(H)-810(H)MM

◆1830(W)×2440(D)×410(H)-610(H)MM

◆1830(W)×2440(D)×610(H)-810(H)MM

◆2阶梯高度0.41厘米

◆3阶梯高度0.61厘米

FOSHAN HK BUILDING MATERIAL COMPANY

Mobile:0086 15918090620

Tel: 0757-28821990

Email: cocoqiu1987@126.com

Whatsapp:+86 15918090620

Wechat:+86 15918090620

Website:www.hkbuildingmaterial.com